



## TABLE OF CONTENTS

<b>Designation code</b>	
How to read sensor designations	3
<b>Basics ultrasound</b>	
Product series	4
Technical parameters	4
Areas of application	5
<b>Sensors</b>	
One-piece analog and switching proximity switches	6
One-piece analog and switching proximity switches in square housing	9
One-piece analog and switching teach-in proximity switches	11
One-piece analog and switching teach-in proximity switches (with minimum distance)	14
One-piece programmable analog and switching proximity switches	17
Two-piece proximity switches	19
Reflection and one-way ultrasonic barriers	22
<b>Accessories</b>	
Programming kit	24
Programming software	24
Reflector	24
Beam deflector	24
Mounting clamps	24
Mating connectors	25
<b>Product overview</b>	
All sensors at a glance	26



## NOTES

---





## DESIGNATION CODE

Example: **K URT 500 - M 18 K B 93 - A N U - V2 - X**

└──┘
└──┘
└──┘
└──┘
└──┘
└──┘
└──┘
└──┘
└──┘
└──┘
└──┘
└──┘
└──┘

1
2
3
4
5
6
7
8
9
10
11
12

### 1 = Working principle

**UES** Ultrasonic one-way barrier  
**URS** Ultrasonic reflective barrier  
**URT** Ultrasonic reflective sensor

### 11 = Connection

**V2** M12 metal  
**V2/1** M12 plastic  
**RS** Date interface

### 2 = Switching distance / sensing range

### 12 = Additional marks

**X** Customized design with detailed description

### 3 = Design

**M** Cylindrical housing with metrical thread  
**Q** Square housing

### 4 = Housing diameter /edge length

### 5 = Housing material

**E** Stainless Steel  
**K** Plastics  
**M** Brass, nickel-plated

### 6 = Mounting

**B** Shielded

### 7 = Tube length in mm

### 8 = Operating voltage

**D** DC direct current voltage

### 9 = Type of output signal

**AN** Analog      **ANI** Current output  
**ANU** Voltage output

**N** NPN

**P** PNP

### 10 = Function

**A** Changeover

**Ö** N.C.

**S** N.O.



## BASICS ULTRASOUND

Bats are the best known animals using the ultrasonic principle for their orientation. They emit high-frequency sounds and use the echo reflected by objects for recognizing their position and distance.

Ultrasonic sensors serve for the automatic detection of positions and distances of objects. The great advantage of ultrasonic sensors is their independency of the surfaces' characteristics. Ultrasonic sensors from Pulsotronic work with an ultrasonic transducer for sending and receiving sound waves. Specially coded ultrasonic signals are transmitted in a set clock. After reflexion by the target the signals reach the sensor and are decoded. The recorded transit time is converted into distance information data. Due to high carrier frequencies and the latest signal processing technology our sensors guarantee failure-free and precise operation. Analog, digital or switching outputs as well as RS232 and RS485 interfaces serve for circulating data to a pc. Several sensors can be used at the same time via synchronising devices which make it possible to scan structures with sensor arrays.

### Product series

We provide a broad range of ultrasonic sensors, appropriate for applications in various fields. One- and two-piece, analog and programmable proximity sensors as well as ultrasonic barriers. Our sensors ensure high resolution, optimum precision, little minimum distances and long range. They are conform to IP67.

### Technical parameters

#### Targets

Almost all objects and materials reflect ultrasound and can therefore be detected, whether they are fluid, liquid or powdery. Ultrasonic sensors even recognize noise-absorbing substances such as padding or rubber foam. The capacity of these sensors to detect transparent objects is of special importance.

#### Maximum sensing range

The maximum sensing range depends on the targets reflexion capability (dimension, material, surface). Colour and form of the object can vary as long as a sufficient echo is reflected to the sensor. Another advantage of ultrasonic sensors is the detection of very small objects, e.g. wire with a diameter of 0,2mm. However any objects deviating from the ideal reduce the maximum range and also the stability of the result.

#### Sonic beam

The angle of the sonic beam indicates the 3dB limits. Close proximity objects can also be detected outside of the these limits. At maximum distance the target must be placed rectangular to the sonic axis.

#### Measurement range

The measurement range is defined by the maximum sensing range and the minimum measurement distance.

#### Measurement rate

Only when the echo impulse has reached the ultrasonic transducer and the transducer has decayed, a new impulse can be transmitted. Therefore ultrasonic sensors with large measurement distances have low measurement rates and ultrasonic sensors with little measurement distances have high measurement rates.

#### Minimum distance, blind zone

The sensors use a transducer for sending and receiving the ultrasonic impulse. As the transducer cannot send and receive at the same time, there is a blind zone in front of the sensor. In this blind zone the position of an object cannot be detected.

#### Sensing range

The maximum sensing range is the distance in which a sufficient echo can be received by the transducer.



## BASICS ULTRASOUND

### Areas of application

Ultrasonic sensors from Pulsotronic are appropriate for a wide range of different applications. The following list describes some examples.

- **Distance measurement** of machinery parts and other products in motion
- **Detection of moving objects** made of all kind of material, including glass
- **Presence detection of objects**
- **Object counting**
- **Completeness check** in containers (bottles in cartons)
- **Fill level measurement** of bulk storage and liquids in silos and tanks
- **Winding and unwinding control** of coils in the paper, the foil and the textile industry
- **Web tension or loop control** in multi-stage operating processes
- **Sorting control** by measuring the height profile of packing items
- **Position control** by measuring the stacking height and projections on loading machines
- **Collision avoidance** in the case on self-controlled transport vehicles

#### Environmental influences

Environmental conditions such as humidity, dust and smoke don't influence the precision of measurement. The sensors are designed for the use in atmospheric air. The operation in other gases, e.g. carbon monoxide, can result in measurement errors due to the deviating sound velocity and attenuation. Also solvents evaporating from liquids can influence the sensors' function.

All ultrasonic sensors from Pulsotronic work with temperature compensation in order to balance variations in sound velocity caused by thermal fluctuation. Strong motion in air and turbulences cause instability in measurement. Anyway, air stream speeds of several m/s can be handled so that open air applications are possible.

#### Installation

Ultrasonic sensors can be mounted in any desired position as long as deposits on the sensors active surface are prevented. The ultrasonic beam can be re-directed by using reflectors though this causes a decrease of the maximum sensing range. Concentrating the sound beam is possible with a focussing reflector.



Detection of diameter

Loop control

Height measurement

Fill level control

Object counting



# ULTRASONIC SENSORS

## ONE-PIECE ANALOG AND SWITCHING ULTRASONIC SENSORS

### Technical data

<b>Operating voltage</b>	18 ... 30V DC
<b>Max. load current</b>	500mA (400mA KURT1000...)
<b>Short circuit protection</b>	yes
<b>Angle sonic beam</b>	ca. 8° (ca. 10° KURT5000...)
<b>Output voltage (analog)</b>	0 ... 10V (1 ... 9V KURT1000)
<b>Linearity error (analog)</b>	0,3% (0,5% KURT5000...)
<b>Repeat accuracy (digital)</b>	0,2% (0,5% KURT1000...) / 0,4mm
<b>Switch-point adjustment (digital)</b>	potentiometer
<b>Protection class</b>	IP67
<b>Operating temperature</b>	-15°C ... +70°C (KURT1000... -10°C ... +60°C )



### Dimensions

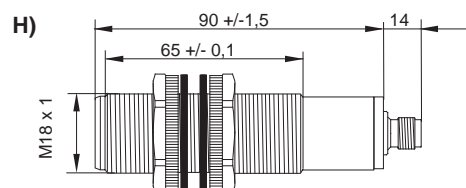
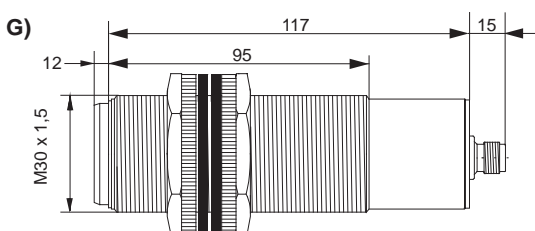
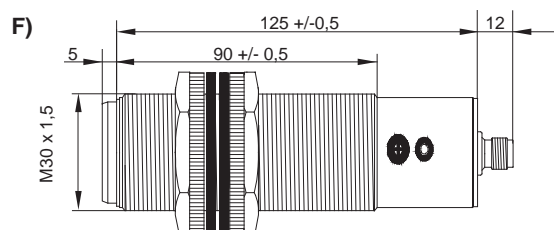
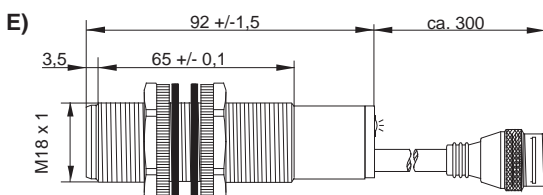
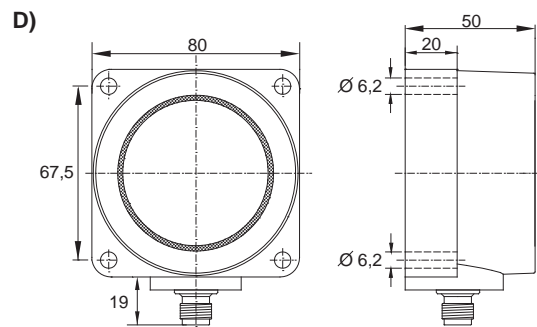
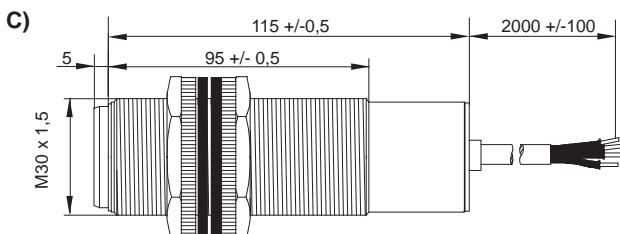
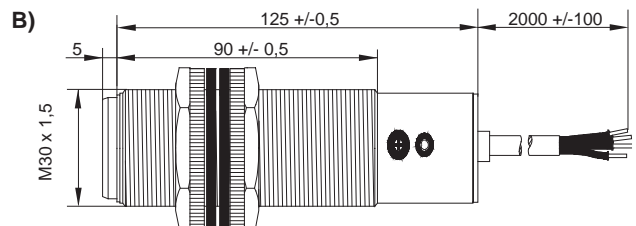
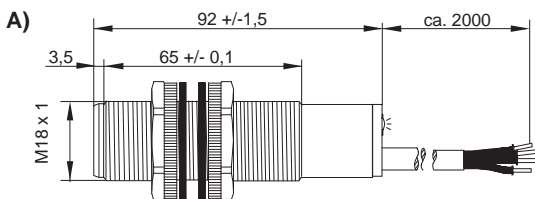

all data in mm





## ONE-PIECE ANALOG AND SWITCHING ULTRASONIC SENSORS

### Connector pin assignment

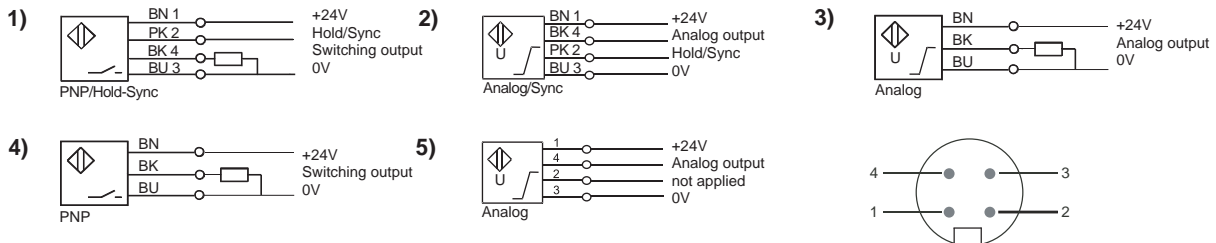

### Sonic beams

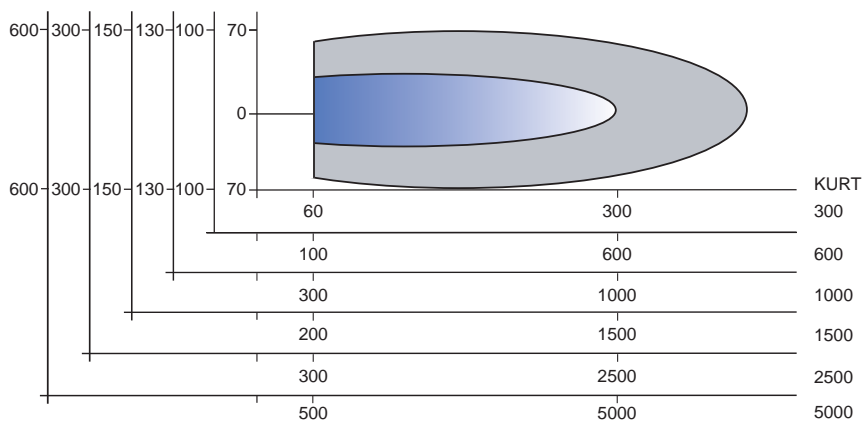

- Safe detection of a norm target vertical to the beam axis
- Possible detection of large target

all data in mm

### Accessories

Article number	Designation
44505160900	Mating connector M12 5-pole freely convertible (V2-5/PG7)
44505129000	Mating connector M12 5-pole, 2m cable PUR 5 x 0,5mm <sup>2</sup> (V2-5/P/2m)
08405160000	Reflector M18 plane
08405160100	Reflector M18 focussing
08405160500	Reflector M30 plane
08405162000	Reflector M30 focussing
08405160650	Beam deflector M18 plastic
08405160600	Beam deflector M30 plastic
08349481900	Mounting clamp M18
08349126600	Mounting clamp M30



## ONE-PIECE ANALOG AND SWITCHING ULTRASONIC SENSORS

### Selection chart

Article number	Designation reflex sensor PNP N.O.	Sensing range in mm	Carrier frequency	Response time/switching frequency	Termination	Drawing	Connect. assignment
08409843600	<b>KURT300-M18KB90-DPS</b>	60 - 300	330kHz	20Hz	cable	A	1
08409843630	<b>KURT300-M18KB90-DPS-V2</b>	60 - 300	330kHz	20Hz	connector M12 4-pole	E	1
08409843200	<b>KURT600-M18KB90-DPS</b>	100 - 600	300kHz	20Hz	cable	A	1
08409843230	<b>KURT600-M18KB90-DPS-V2</b>	100 - 600	300kHz	20Hz	connector M12 4-pole	E	1
08401665000	<b>KURT1000-M30MB115-DPS</b>	300 - 1000	200kHz	10Hz	cable	C	4
08409843300	<b>KURT1500-M18KB90-DPS</b>	200 - 1500	180kHz	10Hz	cable	A	1
08409843330	<b>KURT1500-M18KB90-DPS-V2</b>	200 - 1500	180kHz	10Hz	connector M12 4-pole	E	1
08409861200	<b>KURT2500-M30KB106-DPS</b>	300 - 2500	130kHz	5Hz	cable	B	1
08409861263	<b>KURT2500-M30-KB118-DPS-V2</b>	300 - 2500	130kHz	5Hz	connector M12 4-pole	F	1

	Designation reflection sensor analog voltage (ANU)						
08409843700	<b>KURT300-M18KB89-ANU</b>	60 - 300	330kHz	60ms	cable	A	2
08409843763	<b>KURT300-M18KB89-ANU-V2</b>	60 - 300	330kHz	60ms	connector M12 4-pole	H	2
08409843000	<b>KURT600-M18KB89-ANU</b>	100 - 600	300kHz	60ms	cable	A	2
08409843063	<b>KURT600-M18KB89-ANU-V2</b>	100 - 600	300kHz	60ms	connector M12 4-pole	H	2
08407665100	<b>KURT1000-M30MB115-ANU</b>	300 - 1000	200kHz	100ms	cable	C	3
08407665163	<b>KURT1000-M30MB127-ANU-V2/1</b>	300 - 1000	200kHz	100ms	connector M12 4-pole	G	5
08409843100	<b>KURT1500-M18KB89-ANU</b>	200 - 1500	180kHz	120ms	cable	A	2
08409843163	<b>KURT1500-M18KB89-ANU-V2</b>	200 - 1500	180kHz	120ms	connector M12 4-pole	H	2
08409861300	<b>KURT2500-M30-KB106-ANU</b>	300 - 2500	130kHz	200ms	cable	B	2
08409861363	<b>KURT2500-M30KB106-ANU-V2</b>	300 - 2500	130kHz	200ms	connector M12 4-pole	F	2
08409861290	<b>KURT5000-Q80KB50-ANU-V2</b>	500 - 5000	80kHz	400ms	connector M12 4-pole	D	2

Cable: 2m cable PVC 0,25mm<sup>2</sup> UL-listed

NPN, analog, current output as requested





# ULTRASONIC SENSORS

## ONE-PIECE ANALOG AND SWITCHING TEACH-IN ULTRASONIC SENSORS

### Technical data

Angle sonic beam	about 8°
Switch-point adjustment (digital)	Teach-In
Output voltage (analog)	characteristic line teachable (0 ... 10V)
Short circuit protection	yes
Protection class	IP67
Operating temperature	-15°C ... +70°C
Termination	connector M12, 5-pole

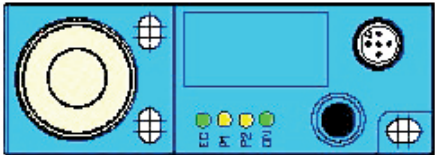

### Dimension

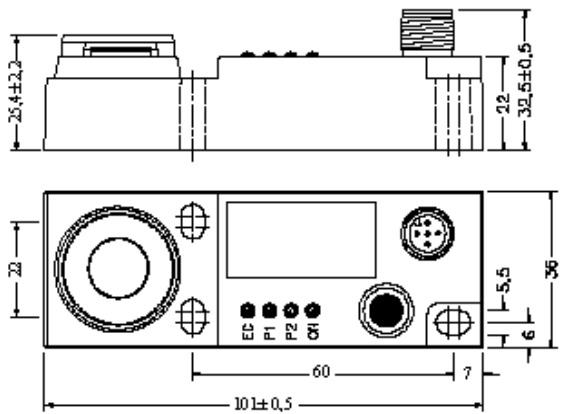

### Connector pin assignment

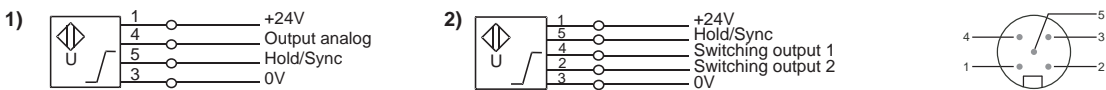

### Sonic beams

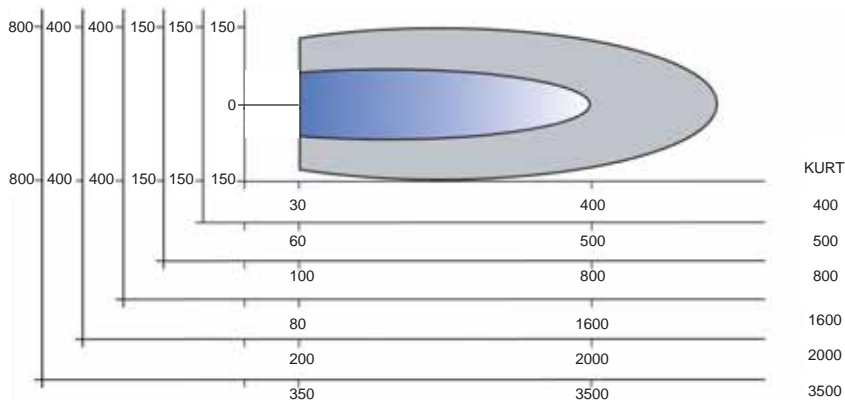

- Guaranteed detection of a norm-object perpendicular to beam axis
- Possible detection of a large target



## ONE-PIECE ANALOG AND SWITCHING TEACH-IN ULTRASONIC SENSORS

### Selection chart

Article-number	Designation reflex sensor Analog U (0 ... 10V)	Sensing range in mm	Carrier frequency	Response time/switching frequency	Repeatability	Connection assignment
08400834563	<b>KURT400-Q100KB-ANU-V2</b>	30 - 400	360kHz	100ms	0,5 mm	1
08400834263	<b>KURT500-Q100KB-ANU-V2</b>	60 - 500	330kHz	100ms	0,2% / 1mm	1
08400834163	<b>KURT800-Q100KB-ANU-V2</b>	100 - 800	300kHz	100ms	0,2% / 2mm	1
08400834463	<b>KURT1600-Q100KB-ANU-V2</b>	80 - 1600	220kHz	140ms	0,2% / 2mm	1
08400834063	<b>KURT2000-Q100KB-ANU-V2</b>	200 - 2000	180kHz	250ms	0,2% / 2mm	1
08400834363	<b>KURT3500-Q100KB-ANU-V2</b>	350 - 3500	130kHz	400ms	0,2% / 2mm	1

Operating voltage 15 ... 30DC, linearity error < 0,5%

	Designation reflex sensor 2 x P PNP-N.O.					
08400836563	<b>KURT400-Q100KB-DPSS-V2</b>	08400834563	360kHz	15Hz	0,5 mm	2
08400836263	<b>KURT500-Q100KB-DPSS-V2</b>	08400834263	330kHz	10Hz	0,2% / 1mm	2
08400836163	<b>KURT800-Q100KB-DPSS-V2</b>	08400834163	300kHz	10Hz	0,2% / 2mm	2
08400836463	<b>KURT1600-Q100KB-DPSS-V2</b>	08400834463	220kHz	6Hz	0,2% / 2mm	2
08400836063	<b>KURT2000-Q100KB-DPSS-V2</b>	08400834063	180kHz	5Hz	0,2% / 2mm	2
08400836363	<b>KURT3500-Q100KB-DPSS-V2</b>	08400834363	130kHz	2,5Hz	0,2% / 2mm	2

Operating voltage 12 ... 30DC, max. load current 500mA  
NPN-, Analog output current on request

### Accessories

Article number	Designation
44505160900	<b>Mating connector M12 5-pole freely convertible (V2-5/PG7)</b>
44505129000	<b>Mating connector M12 5-pole, 2m cable PUR 5 x 0,5mm<sup>2</sup> (V2-5/P/2m)</b>



# ULTRASONIC SENSORS

## ONE-PIECE ANALOG AND SWITCHING TEACH-IN ULTRASONIC SENSORS

### Technical data

Short circuit protection	ca. 8°
Angle sonic beam	± 0,4% / ± 2mm
Repeat accuracy (digital)	Teach-In
Switch-point adjustment (digital)	characteristic line teachable (0 ... 10V)
Output voltage (analog)	yes
Protectin class	IP67
Operating temperature	-15°C ... +70°C



### Dimensions

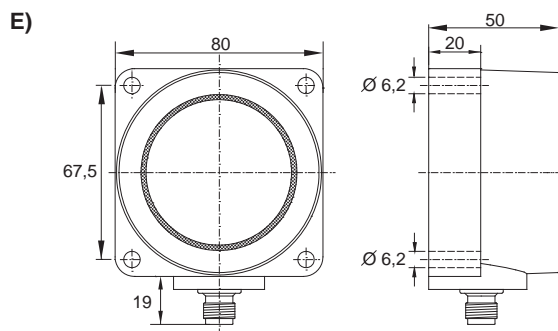
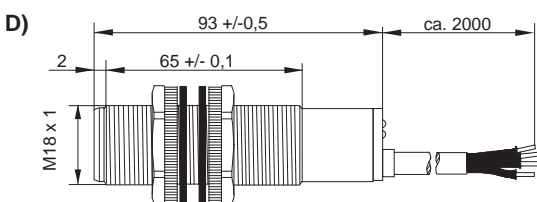
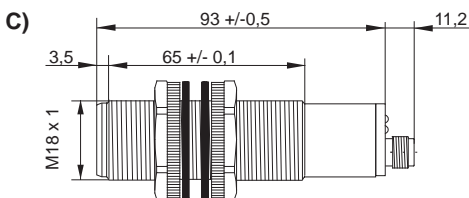
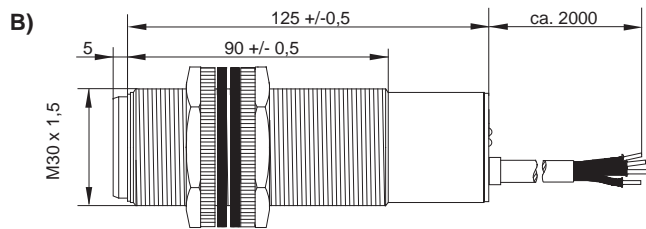
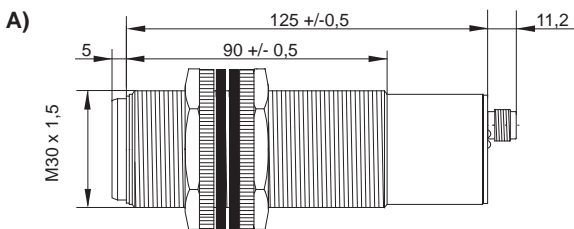

all data in mm

### Connector pin assignment

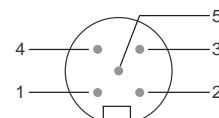
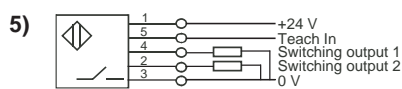
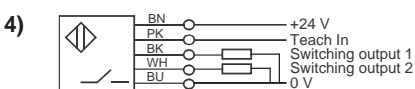
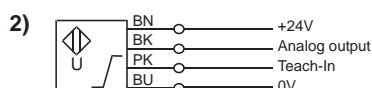
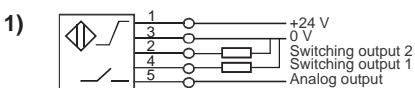



# ONE-PIECE ANALOG AND SWITCHING TEACH-IN ULTRASONIC SENSORS

## Selection chart

Article number	Designation reflex sensor 2 x PNP changeover, analog voltage (ANU)	Sensing range in mm	Carrier frequen- cy	Response time/switching frequency	Termination	Draw- ing	Connect. assign- ment
08409862763	<b>KURT350-M30KB125-ANU-DPA-V2</b>	60 - 350	300kHz	200ms/8Hz	connector M12 5-pole	A	1
08409862663	<b>KURT1500-M30KB125-ANU-DPA-V2</b>	150 - 1500	200kHz	300ms/1Hz	connector M12 5-pole	A	1
08409861063	<b>KURT2000-M30KB125-ANU-DPA-V2</b>	250 - 2000	180kHz	300ms/1Hz	connector M12 5-pole	A	1
08409862563	<b>KURT3500-M30KB125-ANU-DPA-V2</b>	350 - 3500	130kHz	500ms/1Hz	connector M12 5-pole	A	1

Operating voltage 19 ... 30V DC, max. load current 100mA, linearity error 0,5%

	Designation reflex sensor analog voltage (ANU)						
08400830200	<b>KURT500-M18KB93-ANU</b>	60 - 500	330kHz	100ms	cable	D	2
08400830263	<b>KURT500-M18KB93-ANU-V2</b>	60 - 500	330kHz	100ms	connector M12 5-pole	C	3
08400830100	<b>KURT800-M18KB93-ANU</b>	100 - 800	300kHz	100ms	cable	D	2
08400830163	<b>KURT800-M18KB93-ANU-V2</b>	100 - 800	300kHz	100ms	connector M12 5-pole	C	3
08400830000	<b>KURT2000-M18KB93-ANU</b>	200 - 2000	180kHz	250ms	cable	D	2
08400830063	<b>KURT2000-M18KB93-ANU-V2</b>	200 - 2000	180kHz	250ms	connector M12 5-pole	C	3
08400830300	<b>KURT3500-M30KB125-ANU</b>	300 - 3500	130kHz	400ms	cable	B	2
08400830363	<b>KURT3500-M30KB125-ANU-V2</b>	300 - 3500	130kHz	400ms	connector M12 5-pole	A	3
08400830463	<b>KURT6000-Q80KB50-ANU-V2</b>	600 - 6000	80kHz	700ms	connector M12 5-pole	E	3

Cable: 2mcable PVC 3 x 0,34mm<sup>2</sup>

Operating voltage 15 ... 30V DC, linearity error 0,3%

	Designation reflex sensor 2 x PNP N.O.						
08400832200	<b>KURT500-M18KB93-DPSS</b>	60 - 500	330kHz	4,7Hz	cable	D	4
08400832263	<b>KURT500-M18KB93-DPSS-V2</b>	60 - 500	330kHz	4,7Hz	connector M12 5-pole	C	5
08400832100	<b>KURT800-M18KB93-DPSS</b>	100 - 800	300kHz	4,7Hz	cable	D	4
08400832163	<b>KURT800-M18KB93-DPSS-V2</b>	100 - 800	300kHz	4,7Hz	connector M12 5-pole	C	5
08400832000	<b>KURT2000-M18KB93-DPSS</b>	200 - 2000	180kHz	1,2Hz	cable	D	4
08400832063	<b>KURT2000-M18KB93-DPSS-V2</b>	200 - 2000	180kHz	1,2Hz	connector M12 5-pole	C	5
08400832300	<b>KURT3500-M30KB125-DPSS</b>	300 - 3500	130kHz	1,2Hz	cable	B	4
08400832363	<b>KURT3500-M30KB125-DPSS-V2</b>	300 - 3500	130kHz	1,2Hz	connector M12 5-pole	A	5
08400832463	<b>KURT6000-Q80KB50-DPSS-V2</b>	600 - 6000	80kHz	0,5Hz	connector M12 5-pole	E	5

Cable: 2m cable PVC 3 x 0,34mm<sup>2</sup>

Operating voltage 15 ... 30V DC, max. load current 500mA, NPN, analog-/ current output as requested



# ONE-PIECE ANALOG AND SWITCHING TEACH-IN ULTRASONIC SENSORS

## Sonic beams

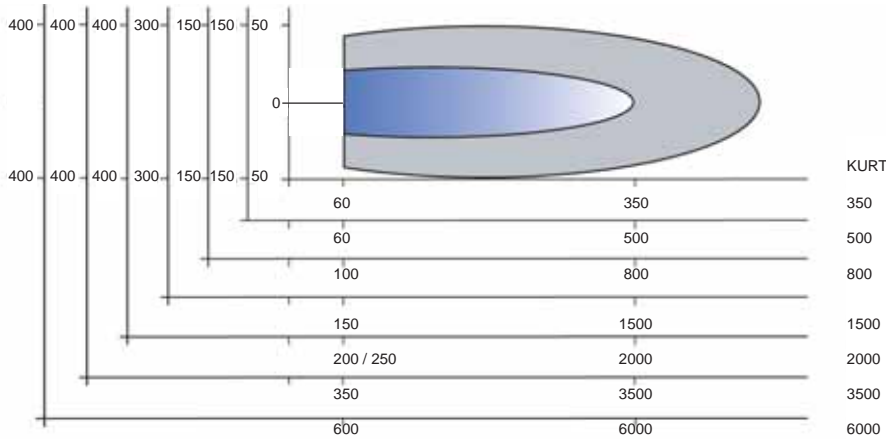

- Guaranteed detection of a norm target vertical to the beam axis
- Possible detection of a large object

all data in mm

## Accessories

Article number	Designation
44505160900	<b>Mating connector M12 5-pole freely convertible (V2-5/PG7)</b>
44505129000	<b>Mating connector M12 5-pole, 2m cable PUR 5 x 0,5mm<sup>2</sup> (V2-5/P/2m)</b>
08405160000	<b>Reflector M18 plane</b>
08405160100	<b>Reflector M18 focussing</b>
08405160500	<b>Reflector M30 plane</b>
08405162000	<b>Reflector M30 focussing</b>
08349481900	<b>Mounting clamp M18</b>
08349126600	<b>Mounting clamp M30</b>
08405160650	<b>Beam deflector M18 plastic</b>
08405160600	<b>Beam deflector M30 plastic</b>



# ULTRASONIC SENSORS

## ONE-PIECE ANALOG AND SWITCHING ULTRASONIC SENSORS WITH LITTLE BLIND ZONE

### Technical data

Angle sonic beam	ca. 8°
Switch point adjustment (digital)	Teach-In
Output voltage (analog)	characteristic line teachable (0 ... 10V)
Repeatability	KURT400... ± 1mm / ± 0,2%
	KURT500... ± 1,6mm / ± 0,5%
	KURT1600... ± 2mm / ± 0,2%
	KURT250-Q12... + 0,2mm / + 0,2%
	KURT200-M12... 0,3mm
Protection class	IP67
Operating temperature	-15°C ... +70°
	(-10°C... +50°C = KURT500-Q18)



### Dimensions

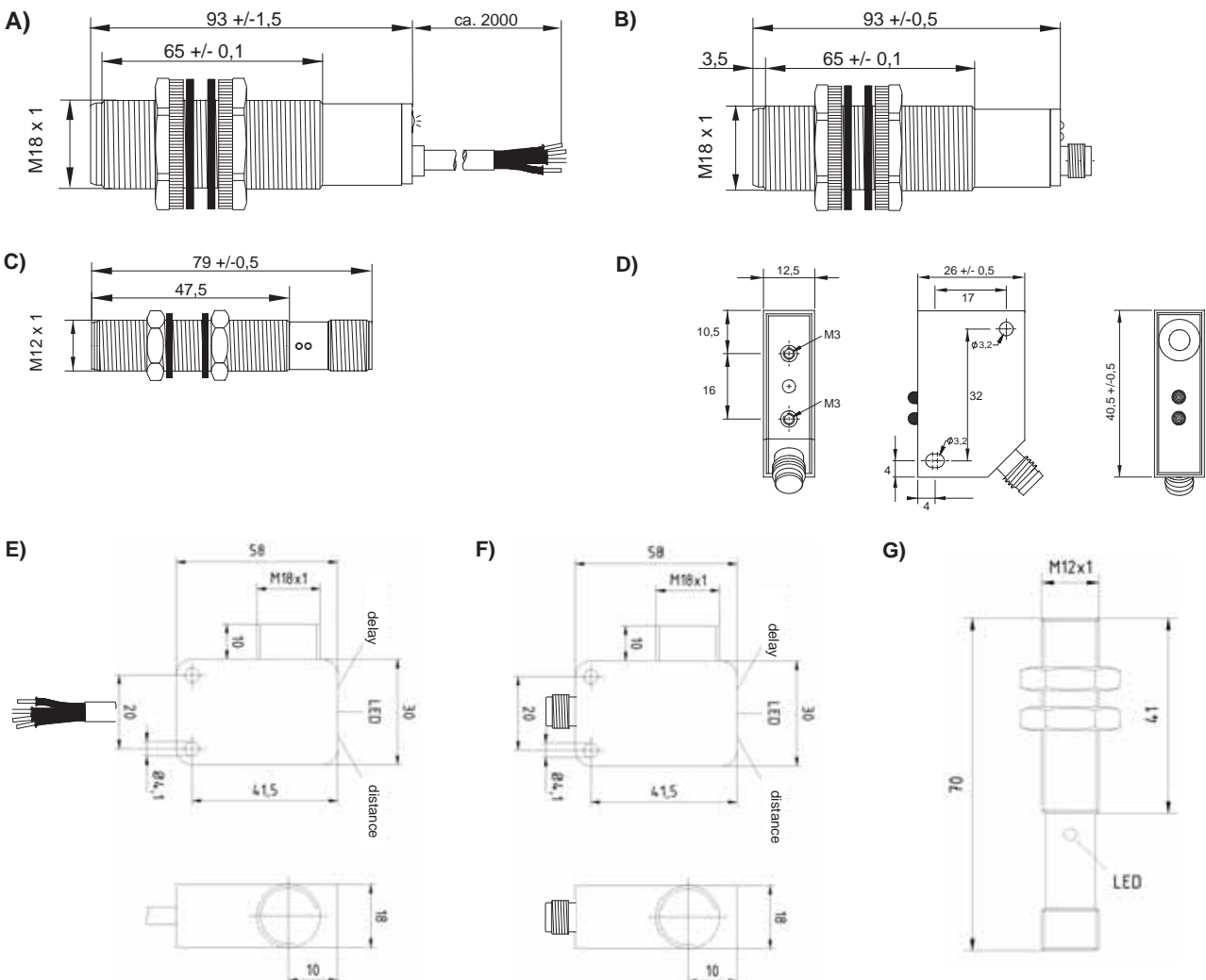

all data in mm





# ONE-PIECE ANALOG AND SWITCHING ULTRASONIC SENSORS WITH LITTLE BLIND ZONE

## Connector pin assignment

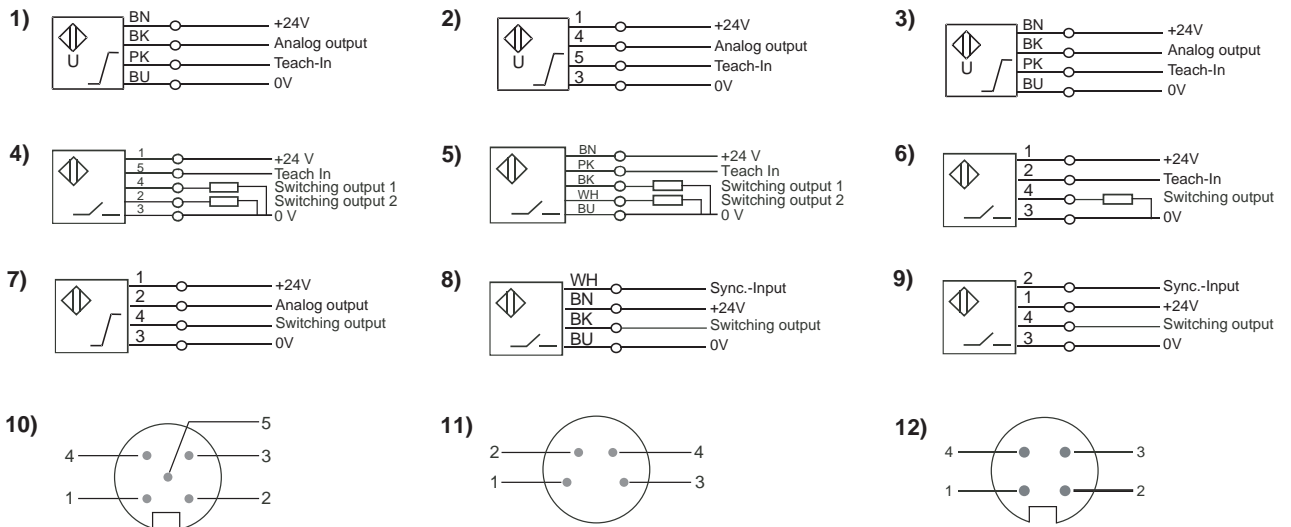

## Selection chart

Article number	Designation analog	Sensing range in mm	Carrier frequency	Response time/Switching frequency	Termination	Drawing	Connector pin assignment
08400830963	<b>KURT200-M12MB70-ANU-V2</b>	20 - 200	400kHz	30ms	connector M12 4-pole	G	7 + 12
08400834664	<b>KURT250-Q12KB-ANU-V1</b>	25 - 250	400kHz	10ms	connector M8 4-pole	D	7 + 11
08400830500	<b>KURT400-M18KB93-ANU</b>	30 - 400	360kHz	25ms	cable	A	1
08400830563	<b>KURT400-M18KB93-ANU-V2</b>	30 - 400	360kHz	25ms	connector M12 5-pole	B	2 + 10
08400830600	<b>KURT1600-M18KB93-ANU</b>	80 - 1600	220kHz	130ms	cable	A	1
08400830663	<b>KURT1600-M18KB93-ANU-V2</b>	80 - 1600	220kHz	130ms	connector M12 5-pole	B	2 + 10
	<b>Designation digital</b>						
08400832963	<b>KURT200-M12EB79-DPS-V2</b>	25 - 200	400kHz	30Hz	connector M12 4-pole	C	6 + 12
08400836664	<b>KURT250-Q12KB-DPA-V1</b>	25 - 250	400kHz	50Hz	connector M8 4-pole	D	6 + 11
08400832500	<b>KURT400-M18KB93-DPSS</b>	30 - 400	360kHz	20Hz	cable	A	5
08400832563	<b>KURT400-M18KB93-DPSS-V2</b>	30 - 400	360kHz	20Hz	connector M12 5-pole	B	4 + 10
08400836700	<b>KURT500-Q18KB-DPA*</b>	100 - 500	175kHz	2Hz	cable	E	8
08400836764	<b>KURT500-Q18KB-DPA-V1*</b>	100 - 500	175kHz	2Hz	connector M8 4-pole	F	9 + 11
08400832600	<b>KURT1600-M18KB93-DPSS</b>	80 - 1600	360kHz	7Hz	cable	A	5
08400832663	<b>KURT1600-M18KB93-DPSS-V2</b>	80 - 1600	360kHz	7Hz	connector M12 5-pole	B	4 + 10

Cable: 2m cable PVC 3 x 0,34mm<sup>2</sup>

\*adjustable time delay (0,2...7sec)



# ONE-PIECE ANALOG AND SWITCHING ULTRASONIC SENSORS

WITH LITTLE BLIND ZONE

## Sonic beams

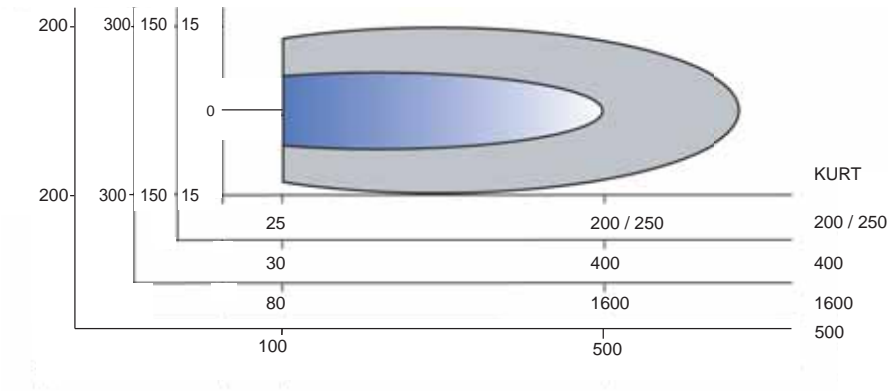

- Guaranteed detection of a target 100 x 100mm<sup>2</sup>
- Possible detection of a large target

all data in mm

## Accessories

Article number	Designation
44505170210	Mating connector M8 4-pole, 2m cable PUR 4 x 0,34mm <sup>2</sup> (V1-4/P/2m)
44505160900	Mating connector M12 5-pole freely convertible (V2-5/PG7)
44505129000	Mating connector M12 5-pole, 2m cable PUR 5 x 0,5mm <sup>2</sup> (V2-5/P/2m)
08405160000	Reflector M18 plane
08405160100	Reflector M18 focussing
08349481900	Mounting clamp M18
08405160650	Beam deflector M18 plastic



# ULTRASONIC SENSORS

## ONE-PIECE PROGRAMMABLE ANALOG AND SWITCHING PROXIMITY SENSORS

### Technical data

Operating voltage	19 ... 30V DC
Max. load current	100mA
Short circuit protection	yes
Angle sonic beam	ca. 8° (ca. 10° KURT1500...)
Output voltage (analog)	programmable (0 ... 10V, 4 ... 20mA)
Linearity error (analog)	0,5%
Hysteresis	programmable
Repeat accuracy	0,4%
Switch point adjustment (digital)	programmable
Software	UDSProg (in delivery programm)
Switching frequency	programmable 5 ... 30Hz
Housing material	stainless steel
Protection class	IP65
Operating temperature	-15°C ... +70°C
Temperature compensation	yes
Termination	connector 8-pole, series Binder 680



### Dimensions, connector pin assignment

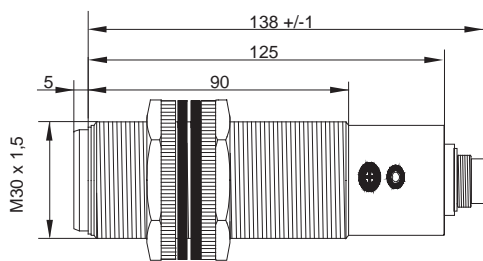

view on soldering contacts (box) or pins (connector)

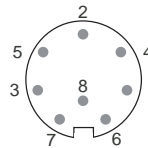

- 1 brown 24V DC
- 2 blue 0V GND
- 3 red Analog output 0 ... 10V/4 ... 20mA
- 4 grey Switching output 1 (PNP)
- 5 white Switching output 2 (PNP)
- 6 green Synchronisation
- 7 yellow RS232 RxD .. RS485-B
- 8 pink RS232 TxD .. RS485-A

all data in mm

### Sonic beams

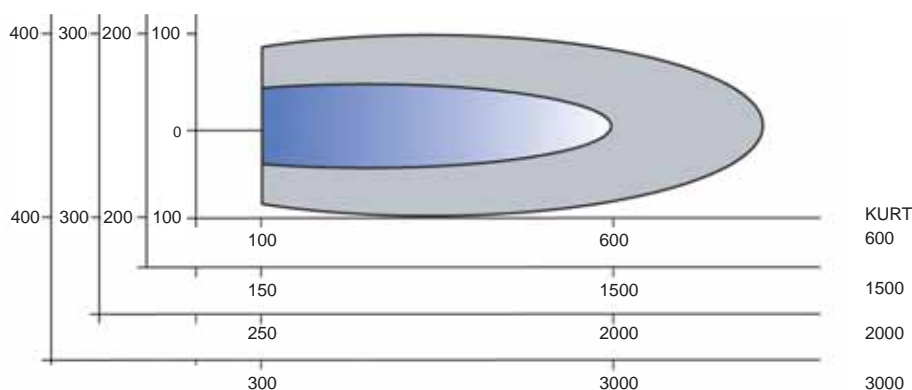

Guaranteed detection of a target 100 x 100mm<sup>2</sup>

Possible detection of a large target

all data in mm

**p-u-l-s-o-t-r-o-n-i-c**  
Pulsotronic GmbH & Co. KG

Neue Schichtstraße 14b  
D-09366 Niederdorf

& +49 (0) 37296 / 930 - 200  
☎ +49 (0) 37296 / 930 - 280

info@pulsotronic.de  
www.pulsotronic.de

subject to  
modifications!



## ONE-PIECE PROGRAMMABLE ANALOG AND SWITCHING PROXIMITY SENSORS

### Selection chart

Article number	Designation reflex sensor 2 x PNP changeover, analog voltage, interface RS232	Sensing range in mm	Carrier frequency	Response time/ switching frequency
08409667200	KURT600-M30EB138-ANU-DPA-RS	100 - 600	300kHz	100ms/5 ... 30Hz
08409667100	KURT1500-M30EB138-ANU-DPA-RS	150 - 1500	220kHz	100ms/5 ... 30Hz
08409667800	KURT2000-M30EB138-ANU-DNA-RS	250 - 2000	180kHz	100ms/5 ... 30Hz
08409667000	KURT3000-M30EB138-ANU-DPA-RS	350 - 3000	130kHz	100ms/5 ... 30Hz

Article number	Designation reflex sensor 2 x PNP changeover, analog current, interface RS232	Sensing range in mm	Carrier frequency	Response time/ switching frequency
08409667600	KURT600-M30EB138-ANI-DPA-RS	100 - 600	300kHz	100ms/5 ... 30Hz
08409667500	KURT1500-M30EB138-ANI-DPA-RS	150 - 1500	220kHz	100ms/5 ... 30Hz
08409667900	KURT2000-M30EB138-ANI-DNA-RS	250 - 2000	180kHz	100ms/5 ... 30Hz
08409667400	KURT3000-M30EB138-ANI-DPA-RS	350 - 3000	130kHz	100ms/5 ... 30Hz

RS485-interface, plastic housing as requested.

### Accessories

Article number	Designation
08341005300	Programming set
08405160700	Mating connector 8-pole, 3m cable, series Binder 680
08349126600	Mounting clamp M30
08405160500	Reflector M30 plane
08405162000	Reflector M30 focussing
08405160600	Beam deflector M30 plastic

### Programming, adjustment

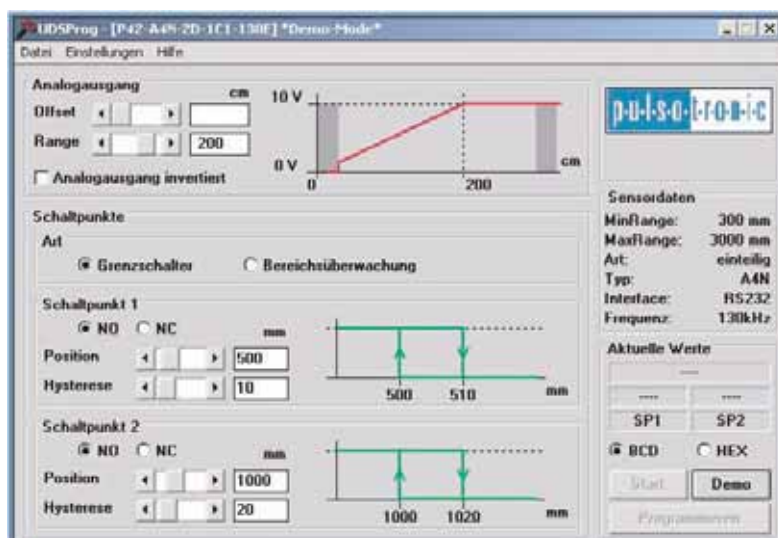

These devices are equipped with two programmable switching points, an analog output and a digital data output. The switching points, hysteresis, pitch and offset of the analog output and many other operating parameters are programmable via the integrated interface. Furthermore the devices can be assigned an adress. The current distance in mm can be displayed permanently or retrieved on request.

Via the potentiometer the reception sensitivity can be adjusted in a wide range. The integrated LED provides information about the intensity of the received echo.



# ULTRASONIC SENSORS

## TWO-PIECE ULTRASONIC SENSORS

### Technical data

Operating voltage	19 ... 30V DC
Max. load current	100mA
Short circuit protection	yes
Angle sonic beam	ca. 8° (ca. 30° KURT8000...)
Output voltage (analog)	programmable (0 ... 10V, 4 ... 20mA)
Linearity error (analog)	0,3% (ca. 0,5% KURT8000...)
Hysteresis	1%
Repeat accuracy (digital)	0,4% (0,2% KURT900...; 0,5% KURT8000...)
Switch-point adjustment (digital)	rotary switch or programmable
Software	UDSProg (in product range)
Switching frequency	programmable (5 ... 30Hz)
Housing material sensor face	stainless steel
Housing material evaluation unit	plastics
Protection class sensor face	IP65
Protection class evaluation unit	IP40
Operating temperature sensor face	0°C ... +70°C
Operating temperature evaluation unit	0°C ... +50°C
Temperature compensation	yes
Termination sensor face	connector 7-pole, series Binder 680 (M12, 5-pole KURT8000...)
Termination evaluation unit	screw terminal

### Dimensions

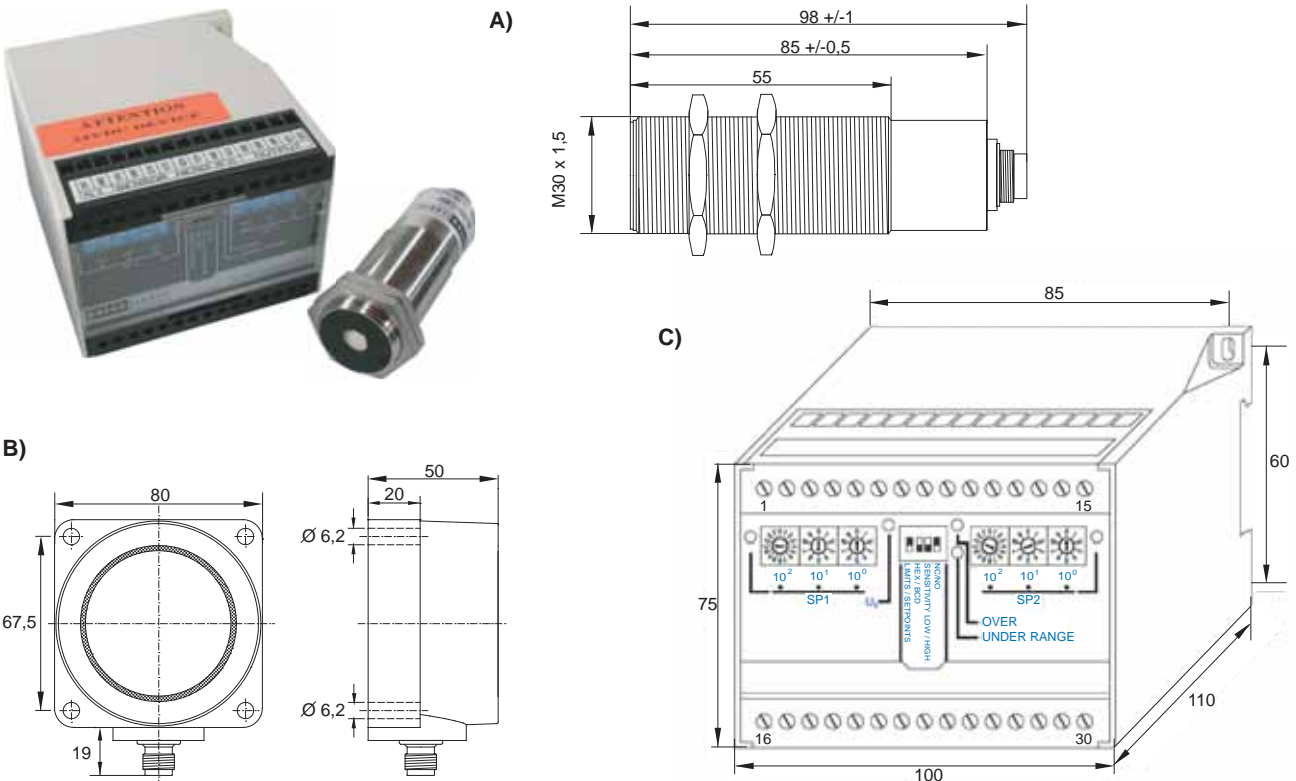

all data in mm

<p>Pulsotronic GmbH &amp; Co. KG</p>	<p>Neue Schichtstraße 14b D-09366 Niederdorf</p>	<p>&amp; +49 (0) 37296 / 930 - 200 +49 (0) 37296 / 930 - 280</p>	<p>info@pulsotronic.de www.pulsotronic.de</p>	<p>subject to modifications!</p>
--------------------------------------	--	--	---	--------------------------------------





# ULTRASONIC SENSORS

## TWO-PIECE ULTRASONIC SENSORS

### Connector pin assignment

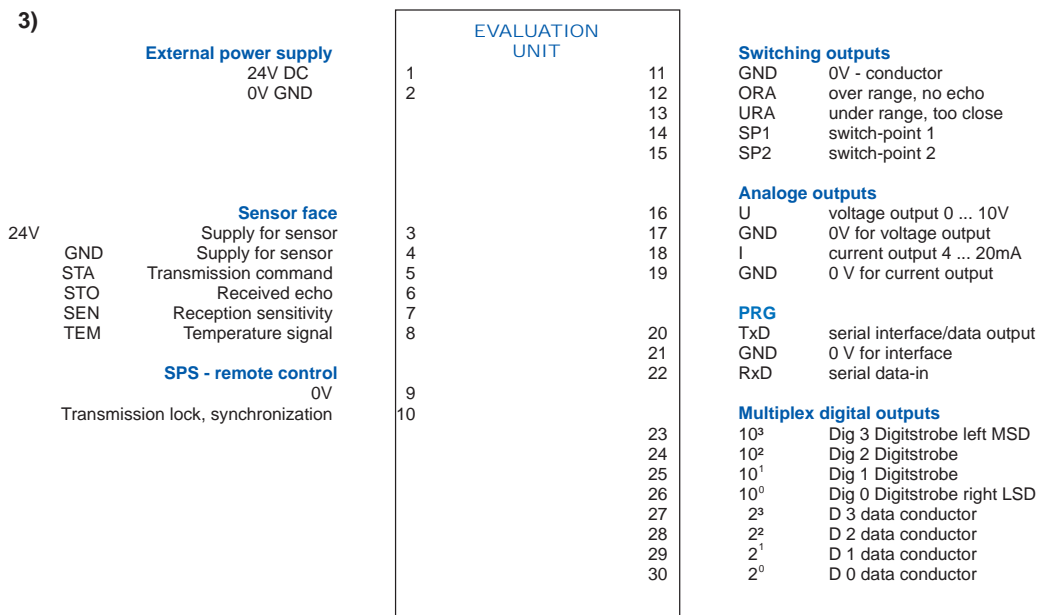
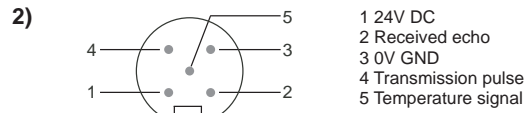
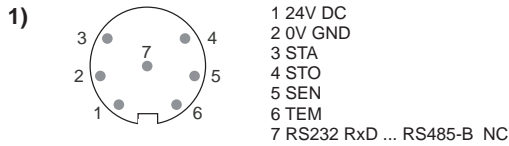

### Sonic beams

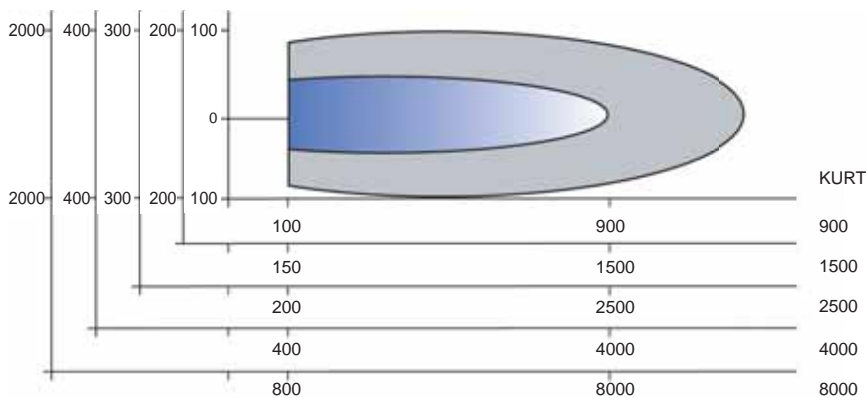

- Guaranteed detection of a norm target vertical to the beam axis
- Possible detection of a large target

all data in mm





## TWO-PIECE ULTRASONIC SENSORS

### Accessories

Article number	Designation
44505161250	Programming software with RS232 cable
44505160900	Mating connector M12 5-pole freely convertible (V2-5/PG7)
44505129000	Mating connector M12 5-pole, 2m cable PUR 5 x 0,5mm <sup>2</sup> (V2-5/P/2m)
08405161800	Mating connector 7-pole, series Binder 680
08349126600	Mounting clamp M30
08405160500	Reflector M30 plane
08405162000	Reflector M30 focussing
08405160600	Beam deflector M30 plastic

### Selection chart

Article number	Designation reflex sensor (sensor face with control unit) 4 x PNP N.O., analog U/I, RS232	Sensing range in mm	Carrier frequency	Response time /switching frequency	Drawing	Connector pin assignment
08401007400	KURT900-M30EB100-ANA-DPS-RS	100 - 900	300kHz	120ms/5Hz	A+C	1+3
08401007300	KURT1500-M30EB100-ANA-DPS-RS	150 - 1500	220kHz	300ms/1Hz	A+C	1+3
08401007100	KURT2500-M30EB100-ANA-DPS-RS	250 - 2500	180kHz	300ms/1Hz	A+C	1+3
08401007000	KURT4000-M30EB100-ANA-DPS-RS	400 - 4000	130kHz	600ms/1Hz	A+C	1+3
08401007470	KURT8000-Q80KB40-ANA-DPS-RS	800 - 8000	65kHz	600ms/1Hz	B+C	2+3

### Programming

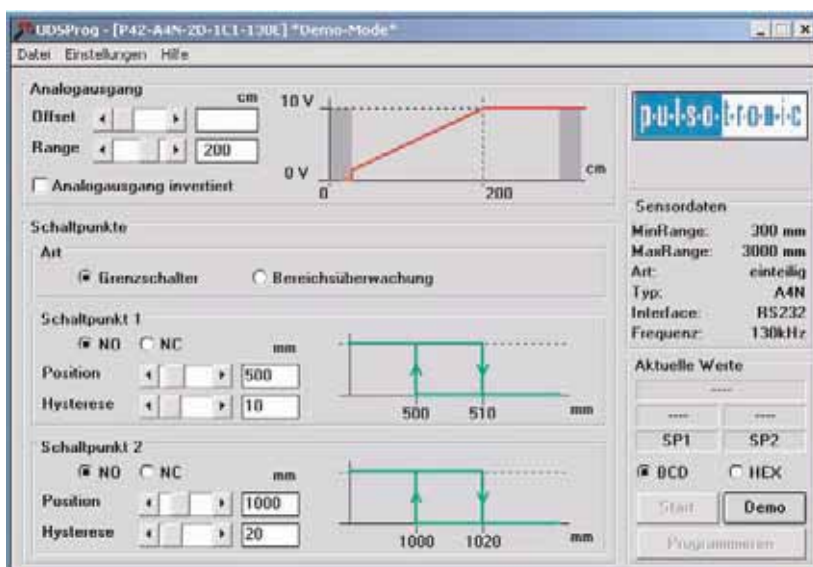

In addition to range-proportional current and voltage outputs with two fixed and two adjustable switch-points these sensors possess data outputs supporting a four-figure digital display. After validation, calculating the sonic speed for the ambient temperature and moving average determination, the detected distance is reported via the voltage and current outputs.

The processor compares the detected distance with the set target values and switches the outputs accordingly. Data may be transferred to a four-figure LCD-display or may be processed as requested. The 4-pole dip switch determines the operating mode of the sensor. The device can be adapted to the application via a serial interface.



# ULTRASONIC SENSORS

## REFLECTION AND ONE-WAY ULTRASONIC BARRIERS

### Technical data

Operating voltage	18 ... 30V DC
Max. load current	500mA
Short circuit protection	yes
Angle sonic beam reflection barrier	ca. 8°
Angle sonic beam one-way barrier	ca. 15°
Switch-point adjustment	potentiometer (only reflection barrier)
Protection class	IP67
Operating temperature reflection barrier	-15°C ... +70°C
Operating temperature one-way barrier	-15°C ... +60°C



### Dimensions

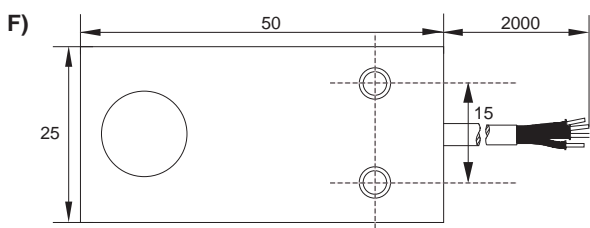
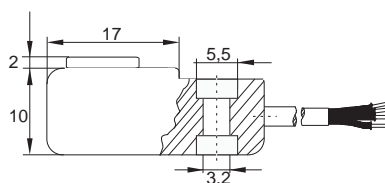
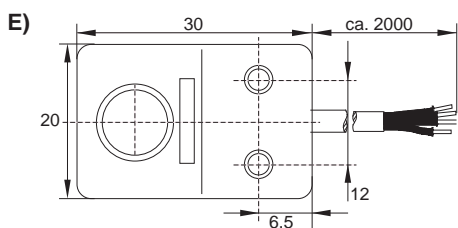
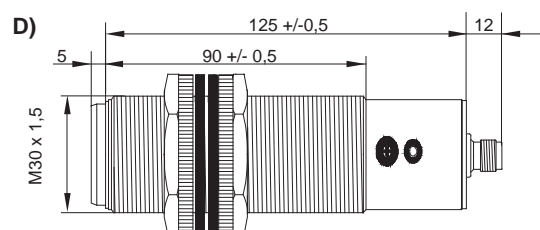
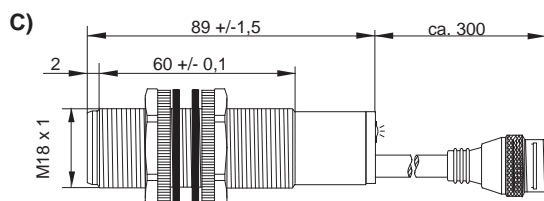
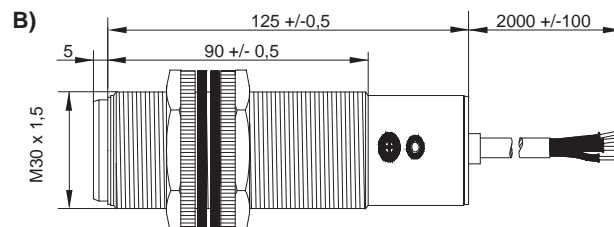
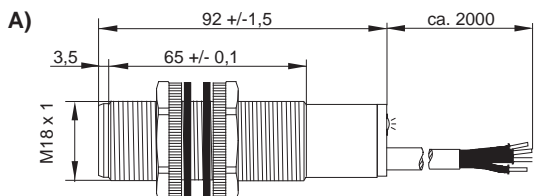

all data in mm



## REFLECTION AND ONE-WAY ULTRASONIC BARRIERS

### Connector pin assignment

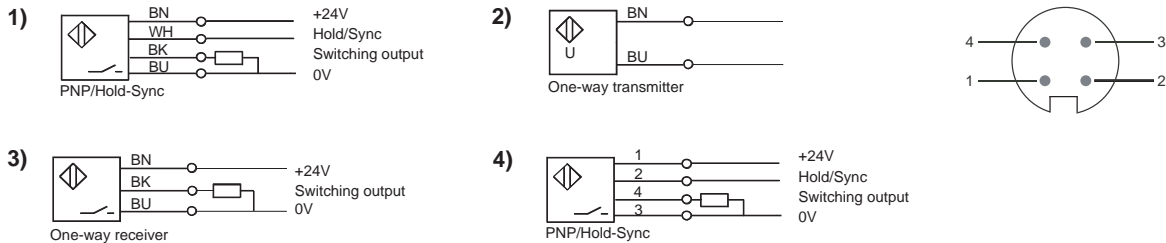

### Selection chart

Article number	Designation reflection barriers	Sensing range in mm	Carrier frequency	Response time/switching frequency	Termination	Drawing	Connector pin assignment
08409843400	<b>KURS600-M18KB90-DPS</b>	600	300kHz	25Hz	cable	A	1
08409843430	<b>KURS600-M18KB90-DPS-V2</b>	600	300kHz	25Hz	connector M12 4-pole	C	4
08409843500	<b>KURS1500-M18KB90-DPS</b>	1500	180kHz	8Hz	cable	A	1
08409843530	<b>KURS1500-M18KB90-DPS-V2</b>	1500	180kHz	8Hz	connector M12 4-pole	C	4
08409861400	<b>KURS2500-M30KB115-DPS</b>	2500	130kHz	1Hz	cable	B	1
08409861463	<b>KURS2500-M30KB118-DPS-V2</b>	2500	130kHz	1Hz	connector M12 4-pole	D	4

Cable: 2m cable PVC 4 x 0,25mm<sup>2</sup> UL-listed

Article number	Designation one-way barrier	Sensing range in mm	Carrier frequency	Response time/switching frequency	Termination	Drawing	Connector pin assignment
08409862000	<b>KUES300-Q20KB-DPS</b>	300	300kHz	150Hz	cable	E	2+3
08409862100	<b>KUES300-Q20KB-DNS</b>	300	300kHz	150Hz	cable	E	2+3
08409862200	<b>KUES300-Q20KB-DPÖ</b>	300	300kHz	150Hz	cable	E	2+3
08409862300	<b>KUES300-Q20KB-DNÖ</b>	300	300kHz	150Hz	cable	E	2+3
08409862500	<b>KUES1100-Q25KB-DPS</b>	1100	180kHz	150Hz	cable	F	2+3
08409862600	<b>KUES1100-Q25KB-DNS</b>	1100	180kHz	150Hz	cable	F	2+3
08409862700	<b>KUES1100-Q25KB-DPÖ</b>	1100	180kHz	150Hz	cable	F	2+3
08409862800	<b>KUES1100-Q25KB-DNÖ</b>	1100	180kHz	150Hz	cable	F	2+3

Cable: 2m cable PVC 4 x 0,25mm<sup>2</sup> UL-listed

### Accessories

Article number	Designation
08349481900	<b>Mounting clamp M18</b>
08349126600	<b>Mounting clamp M30</b>



# ULTRASONIC SENSORS

## ACCESSORIES

### Programming kit, programming software

Article number	Designation
08341005300	Programming kit (adaptor, RS232 cable, software)
44505161250	Programming software with RS232 cable



### Reflectors, beam deflectors

Article number	Designation
08405160000	Reflector M18 plane
08405160100	Reflector M18 focussing
08405160500	Reflector M30 plane
08405162000	Reflector M30 focussing

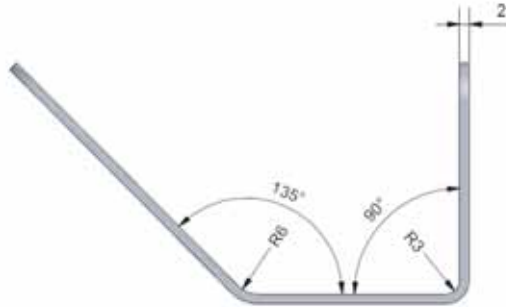

Article number	Designation
08405160650	Beam deflector M18 plastic
08405160600	Beam deflector M30 plastic



### Mounting clamps

Article number	Designation
08349481900	Mounting clamp M18
08349126600	Mounting clamp M30





## ULTRASONIC SENSORS

### ACCESSORIES

#### Mating connectors

Article number	Designation
44505170210	Mating connector M8 4-pole, 2m cable PUR 4 x 0,34mm <sup>2</sup> (V1-4/P/2m)



44505160900	Mating connector M12 5-pole, freely convertible (V2-5/PG7)
44505129000	Mating connector M12 5-pole, 2m cable PUR 5 x 0,5mm <sup>2</sup> (V2-5/P/2m)



08405161800	Mating connector 7-pole, 3m cable, series Binder 680
08405160700	Mating connector 8-pole, 3m cable, series Binder 680







## PRODUCT OVERVIEW

### One-piece analog and switching ultrasonic sensors

Product group	Designation	Article number	Matchcode	Page
Ultrasonic	KURT300-M18KB90-DPS	08409843600	9984-3600	6
Ultrasonic	KURT300-M18KB90-DPS-V2	08409843630	9984-3630	6
Ultrasonic	KURT300-M18KB89-ANU	08409843700	9984-3700	6
Ultrasonic	KURT300-M18KB98-ANU-V2	08409843763		6
Ultrasonic	KURT600-M18KB90-DPS	08409843200	9984-3200	6
Ultrasonic	KURT600-M18KB90-DPS-V2	08409843230	9984-3230	6
Ultrasonic	KURT600-M18KB89-ANU	08409843000	9984-3000	6
Ultrasonic	KURT600-M18KB98-ANU-V2	08409843063	9984-3063	6
Ultrasonic	KURT1000-M30MB115-DPS	08401665000	9966-5000	6
Ultrasonic	KURT1000-M30MB115-ANU	08407665100	9966-5100	6
Ultrasonic	KURT1000-M30MB127-ANU-V2/1	08407665163		6
Ultrasonic	KURT1500-M18KB90-DPS	08409843300	9984-3300	6
Ultrasonic	KURT1500-M18KB90-DPS-V2	08409843330	9984-3330	6
Ultrasonic	KURT1500-M18KB89-ANU	08409843100	9984-3100	6
Ultrasonic	KURT1500-M18KB89-ANU-V2	08409843163	9984-3163	6
Ultrasonic	KURT2500-M30KB106-DPS	08409861200	9986-1200	6
Ultrasonic	KURT2500-M30KB118-DPS-V2	08409861263	9986-1263	6
Ultrasonic	KURT2500-M30KB106-ANU	08409861300	9986-1300	6
Ultrasonic	KURT2500-M30KB106-ANU-V2	08409861363	9986-1363	6
Ultrasonic	KURT5000-Q80KB50-ANU-V2	08409861290	9986-1290	6

### One-piece analog and switching Teach-In ultrasonic sensors in square housing

Product group	Designation	Article number	Matchcode	Page
Ultrasonic	KURT400-Q100KB-YNU-V2	08400834563		9
Ultrasonic	KURT500-Q100KB-ANU-V2	08400834263		9
Ultrasonic	KURT800-Q100KB-ANU-V2	08400834163		9
Ultrasonic	KURT1600-Q100KB-ANU-V2	08400834463		9
Ultrasonic	KURT2000-Q100KB-ANU-V2	08400834063		9
Ultrasonic	KURT3500-Q100KB-ANU-V2	08400834363		9
Ultrasonic	KURT400-Q100KB-DPSS-V2	08400836563		9
Ultrasonic	KURT500-Q100KB-DPSS-V2	08400836263		9
Ultrasonic	KURT800-Q100KB-DPSS-V2	08400836163		9
Ultrasonic	KURT1600-Q100KB-DPSS-V2	08400836463		9
Ultrasonic	KURT2000-Q100KB-DPSS-V2	08400836063		9
Ultrasonic	KURT3500-Q100KB-DPSS-V2	08400836363		9

### One-piece analog and switching teach-in ultrasonic sensors

Product group	Designation	Article number	Matchcode	Page
Ultrasonic	KURT350-M30KB125-ANU-DPA-V2	08409862763	9986-2763	11
Ultrasonic	KURT500-M18KB93-ANU	08400830200	9983-0200	11
Ultrasonic	KURT500-M18KB93-ANU-V2	08400830263	9983-0263	11
Ultrasonic	KURT500-M18KB93-DPSS	08400832200	9983-2200	11
Ultrasonic	KURT500-M18KB93-DPSS-V2	08400832263	9983-2263	11
Ultrasonic	KURT800-M18KB93-ANU	08400830100	9983-0100	11
Ultrasonic	KURT800-M18KB93-ANU-V2	08400830163	9983-0163	11
Ultrasonic	KURT800-M18KB93-DPSS	08400832100	9983-2100	11





## PRODUCT OVERVIEW

### One-piece analog and switching teach-in ultrasonic sensors

Product group	Designation	Article number	Matchcode	Page
Ultrasonic	KURT800-M18KB93-DPSS-V2	08400832163	9983-2163	11
Ultrasonic	KURT1500-M30MB125-ANU-DPA-V2	08409862663	9986-2663	11
Ultrasonic	KURT2000-M30KB125-ANU-DPA-V2	08409861063	9986-1063	11
Ultrasonic	KURT2000-M18KB93-ANU	08400830000	9983-0000	11
Ultrasonic	KURT2000-M18KB93-ANU-V2	08400830063		11
Ultrasonic	KURT2000-M18KB93-DPSS	08400832000		11
Ultrasonic	KURT2000-M18KB93-DPSS-V2	08400832063	9983-2063	11
Ultrasonic	KURT3500-M30KB125-ANU-DPA-V2	08409862563		11
Ultrasonic	KURT3500-M30KB125-ANU	08400830300	9983-0300	11
Ultrasonic	KURT3500-M30KB125-ANU-V2	08400830363	9983-0363	11
Ultrasonic	KURT3500-M30KB125-DPSS	08400832300	9983-2300	11
Ultrasonic	KURT3500-M30KB125-DPSS-V2	08400832363	9983-2363	11
Ultrasonic	KURT6000-Q80KB50-ANU-V2	08400830463		11
Ultrasonic	KURT6000-Q80KB50-DPSS-V2	08400832463		11

### One-piece analog and switching teach-in ultrasonic sensors with little blind zone

Product group	Designation	Article number	Matchcode	Page
Ultrasonic	KURT200-M12MB70-ANU-V2	08400830963		14
Ultrasonic	KURT250-M12EB79-DPS-V2	08400832963	9983-2963	14
Ultrasonic	KURT250-Q12KB-DPA-V1	08400836664	9983-6664	14
Ultrasonic	KURT250-Q12KB-ANU-V1	08400834664	9983-4664	14
Ultrasonic	KURT400-M18KB93-ANU	08400830500	9983-0500	14
Ultrasonic	KURT400-M18KB93-ANU-V2	08400830563	9983-0563	14
Ultrasonic	KURT400-M18KB93-DPSS	08400832500		14
Ultrasonic	KURT400-M18KB93-DPSS-V2	08400832563	9983-2563	14
Ultrasonic	KURT500-Q18KB-DPA	08400836700		14
Ultrasonic	KURT500-Q18-KB-DPA-V1	08400836764		14
Ultrasonic	KURT1600-M18KB93-ANU	08400830600		14
Ultrasonic	KURT1600-M18KB93-ANU-V2	08400830663	9983-0663	14
Ultrasonic	KURT1600-M18KB93-DPSS	08400832600	9983-2600	14
Ultrasonic	KURT1600-M18KB93-DPSS-V2	08400832663		14

### One-piece programmable and switching ultrasonic sensors

Product group	Designation	Article number	Matchcode	Page
Ultrasonic	KURT600-M30EB138-ANU-DPA-RS	08409667200	9966-7200	17
Ultrasonic	KURT600-M30EB138-ANI-DPA-RS	08409667600	9966-7600	17
Ultrasonic	KURT1500-M30EB138-ANU-DPA-RS	08409667100	9966-7100	17
Ultrasonic	KURT1500-M30EB138-ANI-DPA-RS	08409667500	9966-7500	17
Ultrasonic	KURT2000-M30EB138-ANU-DNA-RS	08409667800		17
Ultrasonic	KURT2000-M30EB138-ANI-DNA-RS	08409667900	9966-7900	17
Ultrasonic	KURT3000-M30EB138-ANU-DPA-RS	08409667000		17
Ultrasonic	KURT3000-M30EB138-ANI-DPA-RS	08409667400	9966-7400	17



## PRODUCT OVERVIEW

### Two-piece ultrasonic sensors

Product group	Designation	Article number	Matchcode	Page
Ultrasonic	KURT900-M30EB100-ANA-DPS-RS	08401007400	8100-7400	19
Ultrasonic	KURT1500-M30EB100-ANA-DPS-RS	08401007300	8100-7300	19
Ultrasonic	KURT2500-M30EB100-ANA-DPS-RS	08401007100	8100-7100	19
Ultrasonic	KURT4000-M30EB100-ANA-DPS-RS	08401007000	8100-7000	19
Ultrasonic	KURT8000-Q80KB40-ANA-DPS-RS	08401007470	8100-7470	19

### Ultrasonic reflection and one-way barriers

Product group	Designation	Article number	Matchcode	Page
Ultrasonic	KURS600-M18KB90-DPS	08409843400		22
Ultrasonic	KURS600-M18KB90-DPS-V2	08409843430	9984-3430	22
Ultrasonic	KURS1500-M18KB90-DPS	08409843500		22
Ultrasonic	KURS1500-M18KB90-DPS-V2	08409843530	9984-3530	22
Ultrasonic	KURS2500-M30KB118-DPS	08409861400		22
Ultrasonic	KURS2500-M30KB118-DPS-V2	08409861463	9986-1463	22
Ultrasonic	KUES300-Q20KB-DPS	08409862000		22
Ultrasonic	KUES300-Q20KB-DNS	08409862100		22
Ultrasonic	KUES300-Q20KB-DPÖ	08409862200		22
Ultrasonic	KUES300-Q20KB-DNÖ	08409862300		22
Ultrasonic	KUES1100-Q25KB-DPS	08409862500		22
Ultrasonic	KUES1100-Q25KB-DNS	08409862600		22
Ultrasonic	KUES1100-Q25KB-DPÖ	08409862700		22
Ultrasonic	KUES1100-Q25KB-DNÖ	08409862800		22

### Accessories

Product group	Designation	Article number	Matchcode	Page
Ultrasonic	Programming kit (adapter, RS232, cable)	08341005300	8100-5300	24
Ultrasonic	Programming Software with RS232 cable	44505161250	9516-1250	24
Ultrasonic	Reflector M18 plane	08405160000	9516-0000	24
Ultrasonic	Reflector M18 focussing	08405160100	9516-0100	24
Ultrasonic	Reflector M30 plane	08405160500	9516-0500	24
Ultrasonic	Reflector M30 focussing	08405162000	9516-2000	24
Ultrasonic	Beam deflector M18 plastic	08405160650	9516-0650	24
Ultrasonic	Beam deflector M30 plastic	08405160600	9516-0600	24
Ultrasonic	Mounting clamp M18	08349481900	9548-1900	24
Ultrasonic	Mounting clamp M30	08349126600	9512-6600	24
Ultrasonic	Mating connector M8, 4-pole	44505170210	9517-0210	25
Ultrasonic	Mating connector M12, 5-pole	44505160900	9516-0900	25
Ultrasonic	Mating connector M12, 5-pole, 2m cable	44505129000	9512-9000	25
Ultrasonic	Mating connector 7-pole	08405161800	9516-1800	25
Ultrasonic	Mating connector 8-pole	08405160700	9516-0700	25