



TABLE OF CONTENT

Designation Code

How to read a sensor designations

3

Selection chart Ranges

All sensors at a glance

4

Functional description

Functional principle opto-electronic sensors

5

Applikations

Application field opto-elektronik sensors

6

Sensors

Cylinder G2/M3

7

Cylinder G4/M5

8

Cylinder G5/M6

9

Square Q3/Q4/Q6

10

Fork Q8/Q40/Q57

12

Amplifier V91

13

Amplifier V10

14

Product overview

All sensors at a glance

15



NOTES



DESIGNATION CODE

Example: **K OES 2000- M 8 M B 48- D M A- V1- IR**

1
2
3
4
5
6
7
8
9
10
11
12

1 = Working principle

O	Optical
OES	One-way light barrier
OLL	Fibre optic device universal*
ORF	Reflex light probe focussed
ORG	Reflex light barrier for transparent objects
ORH	Reflex light probe with background suppression
ORK	Contrast probe
ORP	Polarized reflex light barrier
ORS	Reflex light barrier
ORT	Reflex light probe
OU	Universal
OV	Amplifier

2 = Switching distance / range

...	axial
...W	radial

3 = Housing

G	Cylindrical, without thread
M	Cylindrical, with metrical thread
Q	Square housing

4 = Housing diameter resp. edge lengths of active fields

5 = Housing material

A	Aluminium
E	Stainless steel
K	Plastic
M	Brass, nickel-plated

6 = Mounting

B	Flush
N	Non flush

7 = Dimension in mm

8 = Operating voltage

AZ	AC alternating voltage
D	DC direct voltage
VZ	AC/DC

9 = Type of output signal

blank	Transmitter		
AN	Analogue		
		ANI	Current output
		ANU	Voltage output
H	semi-conductor relay		
M	PNP + NPN		
N	NPN		
P	PNP		
R	Relay		
Z	Two-wire		

10 = Output signal

blank	Transmitter
A	Antivalent
D	Data interface
I	Pulse output
Ö	N.C.
S	N.O.
U	Reversible

11 = Type of connection

blank	Cable 2m
V1	M12 plastic
V2	M5 metal
V2/1	Amphenol Tuchel
V11	AC-connector 1/2"
V12	M18 plastic
VE	Euchner connector
RS232	M12 metal
PG	M8 screw-/snap- in
Mxx	Thread joint metrical
NPT	Thread joint 1/2" NPT
W	2m cable, outgoing line on the side
ZW	Connection box 90°

12 = Additional signs







BL	Blue light	RT	Red light
GN	Green light	UV	Ultraviolet light
IR	Infrared	W	White light

* One-way glas KOLLEG One-way plastic KOLLEP
 Reflex probe glas KOLLTG Reflex light probe plastic KOLLTP
 Reflex light barrier glas KOLLRG
 Reflex light barrier plastic KOLLRP





Selection chart ranges



Cylinder - Sensorhead *

Page	G2 7	M3 7	G4 8	M5 8	G5 9	M6 9
						
Reflective sensor	12/20mm	12/20mm			60/100mm	60/100mm
Through-beam light barrier	100-800mm	300-800mm	1000-2000mm	1000-2000mm	4000mm	4000mm

Square - Sensorhead *

Page	Q3 10	Q4 10	Q6 10
			
Reflective sensor	20-70mm		60/200mm
Fixed-focus reflective sensor		7,5mm	
Retro-reflective light barrier for transparent objects			1500mm
Through-beam light barrier	500/800mm		1000-4000mm

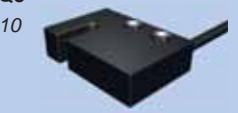
Fork - Sensorhead *

Page	Q8 10	Q40 10	Q57 10
			
Fork width (measurement range)	3mm (4mm)	40mm (8mm)	40mm (30mm)/80mm (30mm)

* to installation with seperate amplifier

Amplifier

Page	V91 13	V10 14
		
Adjustment	Potentiometer	Button, extern Teach-input
Display	LED	LED, Display 3-digit
Sensor pulse extension	0/50ms	0 ... 250ms



FUNCTIONAL DESCRIPTION

Operating types

Reflex light probe

The clocked light of the transmitting diode impinges on the object on which it is reflected diffusely. A part of the reflected light reaches the light receiver situated in the same device. If there is a sufficient receiving energy the output switches (energetic reflex light probe). The maximum range depends on the dimension, colour and surface characteristics of the object.

The function of reflex light probes with background suppression is similar to energetic reflex light probes. The difference is that not the quantity but the angle of incidence of the reflected light is evaluated. Thus the dimension, the colour and the surface characteristics of the object hardly influence the switching distance. This is why objects can also be detected without any problem in front of a bright background.

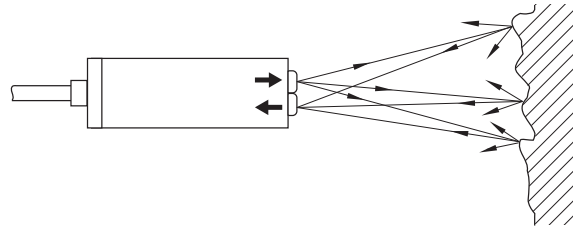

Reflex light barriers (polarized)

The clocked light of the transmitting diode is focussed through a lens and directed on a reflector via a polarisation filter (principle of triple mirror). A part of the light which is reflected there reaches the receiver via another polarisation filter. The arrangement of the filters takes care for only the light which is reflected by the reflector reaching the receiver. This avoids the problem that bright and shining objects are not detected due to direct reflection. An object interrupting the course of beam from the transmitter to the reflector causes the switching of the output. As simplified versions reflex light barriers are also available without polarisation filter.

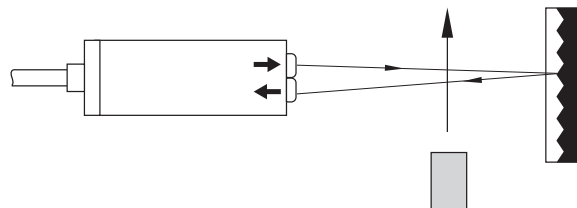

One-way light barriers

One-way light barriers consist of a transmitter and a receiver in two separate housings. The arrangement of the transmitter aims at a maximum part of the clocked light reaching the receiver. An interruption of the light beam between transmitter and receiver causes the switching of the output.

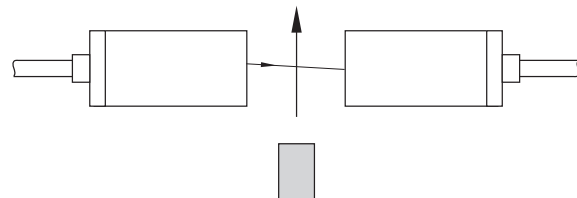



APPLICATIONS

Applications opto-electronical sensors with extern amplifie

Thread control

A mini reflection light proximity switch checks if there is a thread inside a drilled hole. The head of the switch is directed in that way that the transmitted light strikes the thread flanks rectangularly if there is one. The light is reflected from the flanks and the sensor switches when the light strikes the receiver.

If there is no thread inside the drilled hole, the light is reflected away at the wall of the sensor head and does not reach the receiver.

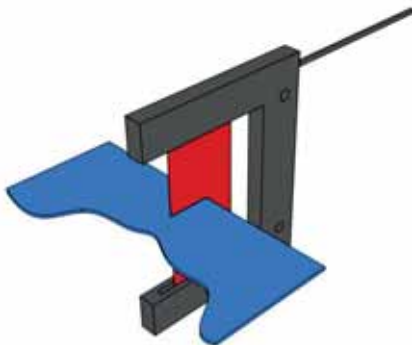
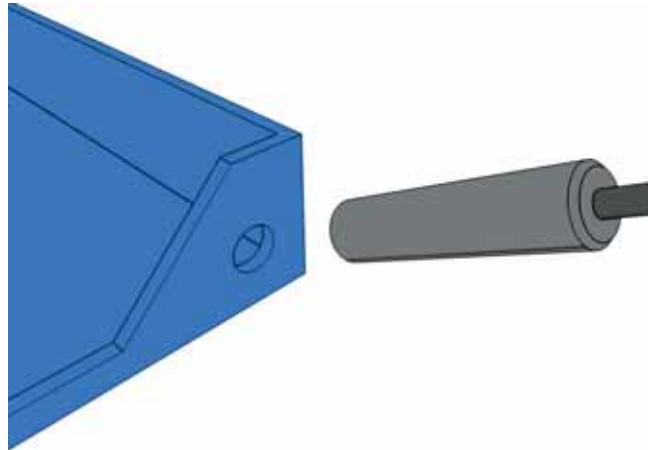

Web edge guider

When processing web material, it is important to have a precise material guidance. Because of this, a light curtain with external amplifier is positioned in that way that the web covers a part of the light beam.

When the web edge leaves its designated position, it is detected by the sensor. A special signal guided to the machine, leads to a counteraction.

Detection of low objects

When processing sheet material, the exact position is crucial to quality. Mostly, standard light barriers are too imprecise or overstrained for scanning edges of thin pieces. Here, an economic alternative to the laser light barrier is a mini light barrier with external amplifier.

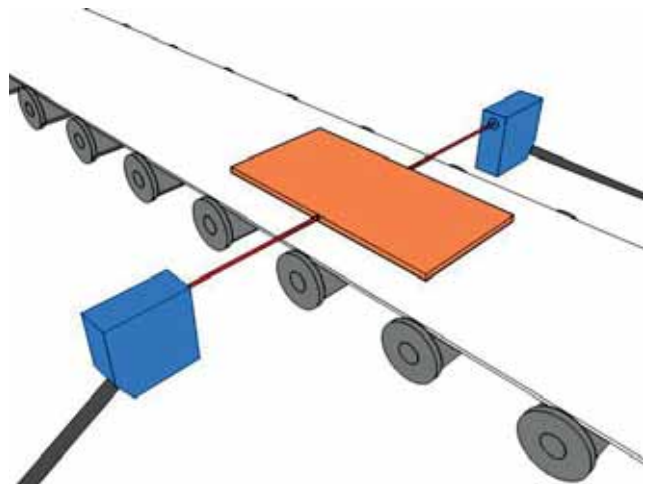



OPTICAL SENSORS MINI

CYLINDER G2/M3

General data

Temperature range	-10°C ... +55°C
Protection class	IP65
Connection to amplifier	1m PUR cable with connector



Selection chart reflective sensor/retro-reflective light - barrier

Article number	Designation	Scanning range	Range to reflector	Switching class	Dimension
08361601100	KORT12-G2EB8-X0301 IR	12mm	250mm	Infra red 880nm	A
08361601150	KORT12-G2EB8-X0301 RL	12mm	250mm	Red light 660nm	A
08361601160	KORT20-G2EB8-X0301 IR	20mm	300mm	Infra red 880nm	A
08361601200	KORT12-M3MB8-X0301 IR	12mm	250mm	Infra red 880nm	B
08361601210	KORT12-M3MB8-X0301 RL	12mm	250mm	Red light 660nm	B
08361601220	KORT20-M3MB8-X0301 IR	20mm	300mm	Infra red 880nm	B

Selection chart through-beam light barrier

Article number	Designation	Scanning range	Smallest object (Ø Cu-Draht)	Switching class	Dimension
08363603200	KOES100-G2EB8-X0301 RL	100mm	0,05mm	Rotlicht 660nm	A
08363603300	KOES200-G2EB8-X0301 RL	200mm	0,1mm	Rotlicht 660nm	A
08363602000	KOES300-G2EB8-X0301 IR	300mm	0,2mm	Infrarot 880nm	A
08363602100	KOES300-G2EB8-X0301 RL	300mm	0,05mm	Rotlicht 660nm	A
08363602200	KOES800-G2EB8-X0301 IR	800mm	0,05mm	Infrarot 880nm	A
08363602150	KOES500-G2EB8-X0301 RLM	500mm	0,04mm	Rotlicht 660nm	A
08363602160	KOES800-G2EB8-X0301 RLN	800mm	0,03mm	Rotlicht 660nm	A
08363602300	KOES300-M3MB8-X0301 IR	300mm	0,2mm	Infrarot 880nm	B
08363602400	KOES300-M3MB8-X0301 RL	300mm	0,05mm	Rotlicht 660nm	B
08363602500	KOES800-M3MB8-X0301 IR	800mm	0,06mm	Infrarot 880nm	B
08363602450	KOES500-M3MB8-X0301 RLM	500mm	0,04mm	Rotlicht 660nm	B
08363602460	KOES800-M3MB8-X0301 RLN	800mm	0,03mm	Rotlicht 660nm	B

Dimension

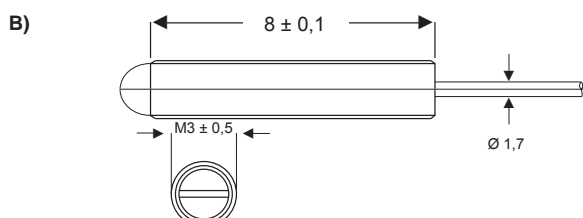
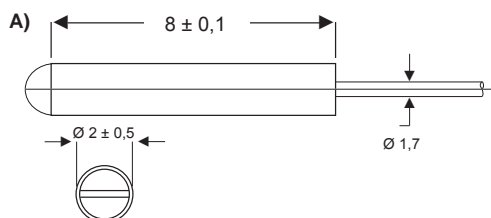

all data in mm



OPTICAL SENSORS MINI

CYLINDER G4/M5

General data

Temperature range	-10°C ... +55°C
Protection class	IP65
Connection to amplifier	1m PUR cable with connector



Selection chart through-beam light barrier

Article number	Designation	Range	Minimum object size	Switching state	Dimension
08363602600	KOES1000-G4EB11-X0301 IR	1000mm	0,3mm	Infra red 880nm	A
08363602610	KOES1000-G4EB11-X0301 RL	1000mm	0,1mm	Red light 660nm	A
08363602700	KOES2000-G4EB11-X0301 IR	2000mm	0,1mm	Infra red 880nm	A
08363602650	KOES2000-G4EB11-X0301 RLM	2000mm	0,1mm	Red light 645nm	A
08363602660	KOES1500-G4EB11-X0301 RLN	1500mm	0,1mm	Red light 645nm	A
08363602800	KOES1000-M5MB11-X0301 IR	1000mm	0,3mm	Infra red 880nm	B
08363602810	KOES1000-M5MB11-X0301 RL	1000mm	0,1mm	Red light 660nm	B
08363602900	KOES2000-M5MB11-X0301 IR	2000mm	0,1mm	Infra red 880nm	B
08363602850	KOES2000-M5MB11-X0301 RLM	2000mm	0,1mm	Red light 645nm	B
08363602860	KOES1500-M5MB11-X0301 RLN	1500mm	0,1mm	Red light 645nm	B

Dimension

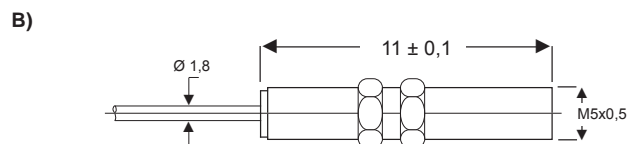
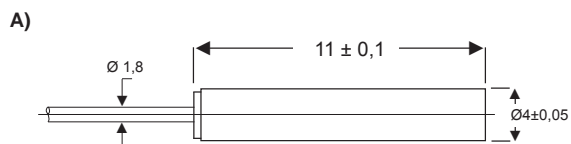

all data in mm



OPTICAL SENSORS MINI

CYLINDER G5/M6

General data

Temperature range	-10°C ... +55°C
Protection class	IP65
Connection to amplifier	1m PUR Cable with connector



Selection chart reflective sensor/retro-reflective light barrier

Article number	Designation	Scanning range	Range of reflector	Switching state	Dimension
08361601300	KORT60-G5EB13-X0301 IR	60mm	800mm	Infra red 880nm	A
08361601400	KORT60-G5EB13-X0301 RL	60mm	800mm	Red light 660nm	A
08361601500	KORT100-G5EB13-X0301 IR	100mm	1200mm	Infra red 880nm	A
08361601450	KORT60-G5EB13-X0301 RLM	60mm	800mm	Red light 645nm	A
08361601600	KORT60-M6MB13-X0301 IR	60mm	800mm	Infra red 880nm	B
08361601700	KORT60-M6MB13-X0301 RL	60mm	800mm	Red light 660nm	B
08361601800	KORT100-M6MB13-X0301 IR	100mm	1200mm	Infra red 880nm	B
08361601750	KORT60-M6MB13-X0301 RLM	60mm	800mm	Red light 645nm	B

Selection chart trough-light beam barrier

Article number	Designation	Scanning range	Minimum object (Ø Cu-Wire)	Switching state	Dimension
08363603000	KOES4000-G5EB13-X0301 IR	4000mm	0,4mm	Infra red 880nm	A
08363603100	KOES4000-M6MB13-X0301 IR	4000mm	0,1mm	Infra red 880nm	B
08363603110	KOES4000-M6MB13-X0301 RL	4000mm	0,1mm	Red light 660nm	B

Dimension

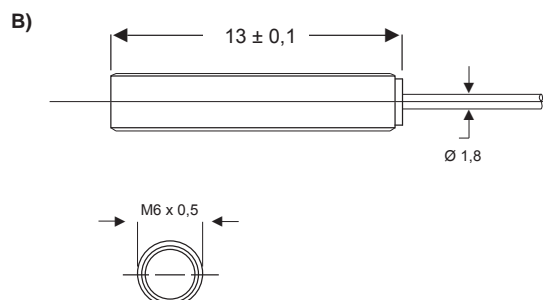
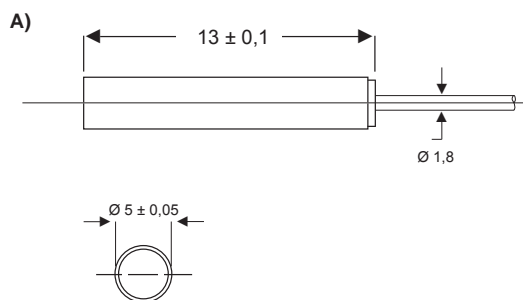

all data in mm



SQUARE Q3/Q4/Q6

General data

Temperature range	-10°C ... +55°C
Protection class	IP65
Connection to amplifier	1m PUR cable with connector



Selection chart reflection sensor/retro-reflective light barrier

Article number	Designation	Scanning range	Range of reflector	Switching state	Dimension
08361600000	KORT60-Q6MB12-X0301 IR	60mm	800mm	Infra red 880nm	A
08361600100	KORT60-Q6MB12-X0301 RL	60mm	800mm	Red light 660nm	A
08361600200	KORT100-Q6MB12-X0301 IR	100mm	1200mm	Infra red 880nm	A
08361600150	KORT60-Q6MB12-X0301 RLM	60mm	800mm	Red light 645nm	A
08361600300	KORT200-Q6MB17-X0301 IR	200mm	3000mm	Infra red 880nm	B
08361602300	KORT60-Q3AB13-X0301 RLM	60mm	1000mm	Red light 645nm	C
08361602310	KORT25-Q3AB13-X0301 RLN	25mm	600mm	Red light 645nm	C
08361602400	KORT60W-Q3AB13-X0301 RLM	60mm	1000mm	Red light 645nm	D
08361602410	KORT25W-Q3AB13-X0301 RLN	25mm	600mm	Red light 645nm	D
08361602200	KORT70-Q3MB-X0301 RLM	70mm	800mm	Red light 645nm	E
08361602210	KORT20-Q3MB-X0301 RLN	20mm	500mm	Red light 645nm	E

Selection chart fixed-focus reflective sensor

Article number	Designation	Scanning range	Light point-diameter	Switching state	Dimension
08361602100	KORF7-Q4MB16-X0301 RLM	7,5mm	1,8mm at the focus	Red light 645nm	F

Selection chart retro-reflective light barrier clear class detection

Article number	Designation	Range of reflector	Switching state	Dimension
08361600400	KORS1500-Q6MB17-X0301 RL	1500mm (500mm)	Red light 660nm	B

Selection chart trough-beam light barrier

Article number	Designation	Range	Minimum object (Ø Cu-wire)	Switching state	Dimension
08363600500	KOES1000-Q6MB12-X0301 IR	1000mm	0,3mm	Infra red 880nm	A
08363600600	KOES2000-Q6MB12-X0301 IR	2000mm	0,1mm	Infra red 880nm	A
08363600620	KOES1000-Q6MB12-X0301 RL	1000mm	0,1mm	Red light 660nm	A
08363600700	KOES4000-Q6MB12-X0301 IR	4000mm	0,1mm	Infra red 880nm	G
08363600720	KOES4000-Q6MB12-X0301 RL	4000mm	0,1mm	Red light 660nm	G
08363603500	KOES500-Q3AB13-X0301 RLM	500mm	0,04mm	Red light 645nm	C
08363603510	KOES800-Q3AB13-X0301 RLN	800mm	0,03mm	Red light 645nm	C
08363603600	KOES500W-Q3AB13-X0301 RLM	500mm	0,04mm	Red light 660nm	D
08363603610	KOES800W-Q3AB13-X0301 RLN	800mm	0,03mm	Red light 645nm	D
08363102470	KOES500-Q3MB5-X0301 RLM	500mm	0,04mm	Red light 645nm	H
08363102480	KOES800-Q3MB5-X0301 RLN	800mm	0,03mm	Red light 645nm	H



OPTICAL SENSORS MINI

SQUARE Q3/Q4/Q6

Dimension

A)

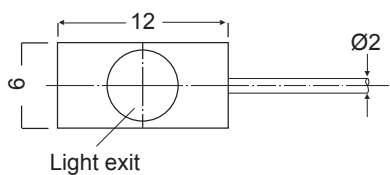
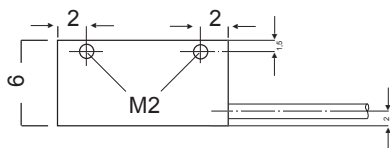

B)

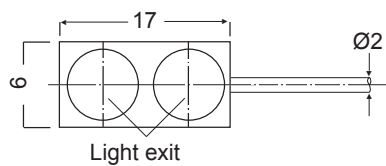
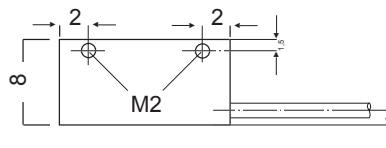

C)

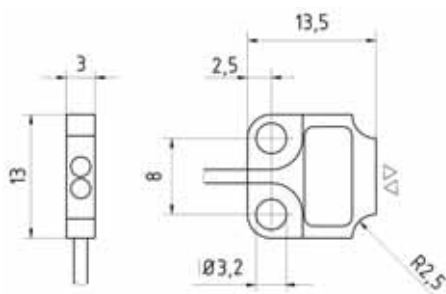

D)

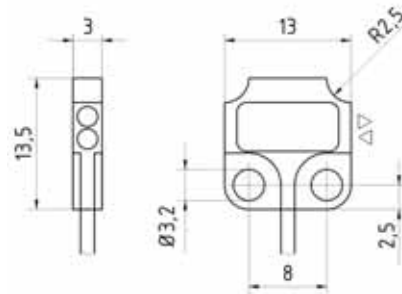

E)

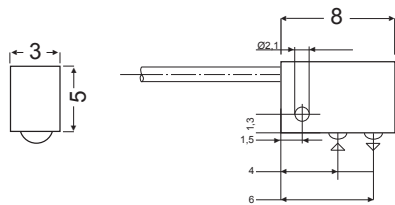

F)

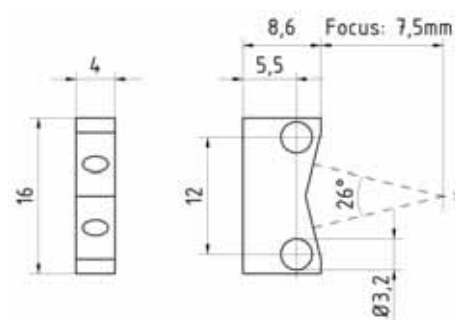

G)

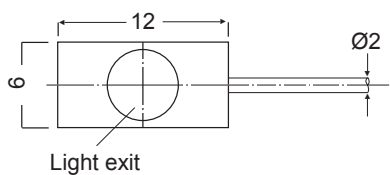
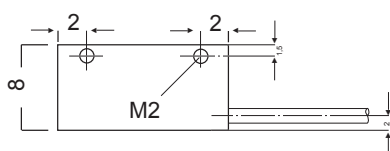

H)

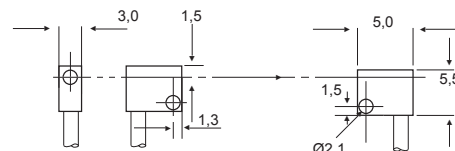

all data in mm



OPTICAL SENSORS MINI

Fork Q8/Q40/Q57

General data

Temperature range	-10°C ... +55°C
Protection class	IP65
Connection to amplifier	1m PUR cable with connector



Selection chart Light-band-fork sensor

Article number	Designation	Fork width	Range	Switching state	Dimension
08363605003	KOEG3-Q8AB4-X0301	3mm	4mm	Red light 650nm	A
08363605005	KOEG40-Q40AB8-X0301	40mm	8mm	Red light 650nm	B
08363605010	KOEG40-Q57AB30-X0301	40mm	30mm	Red light 645nm	C
08363605015	KOEG80-Q57AB30-X0301	80mm	30mm	Red light 645nm	D

Dimension

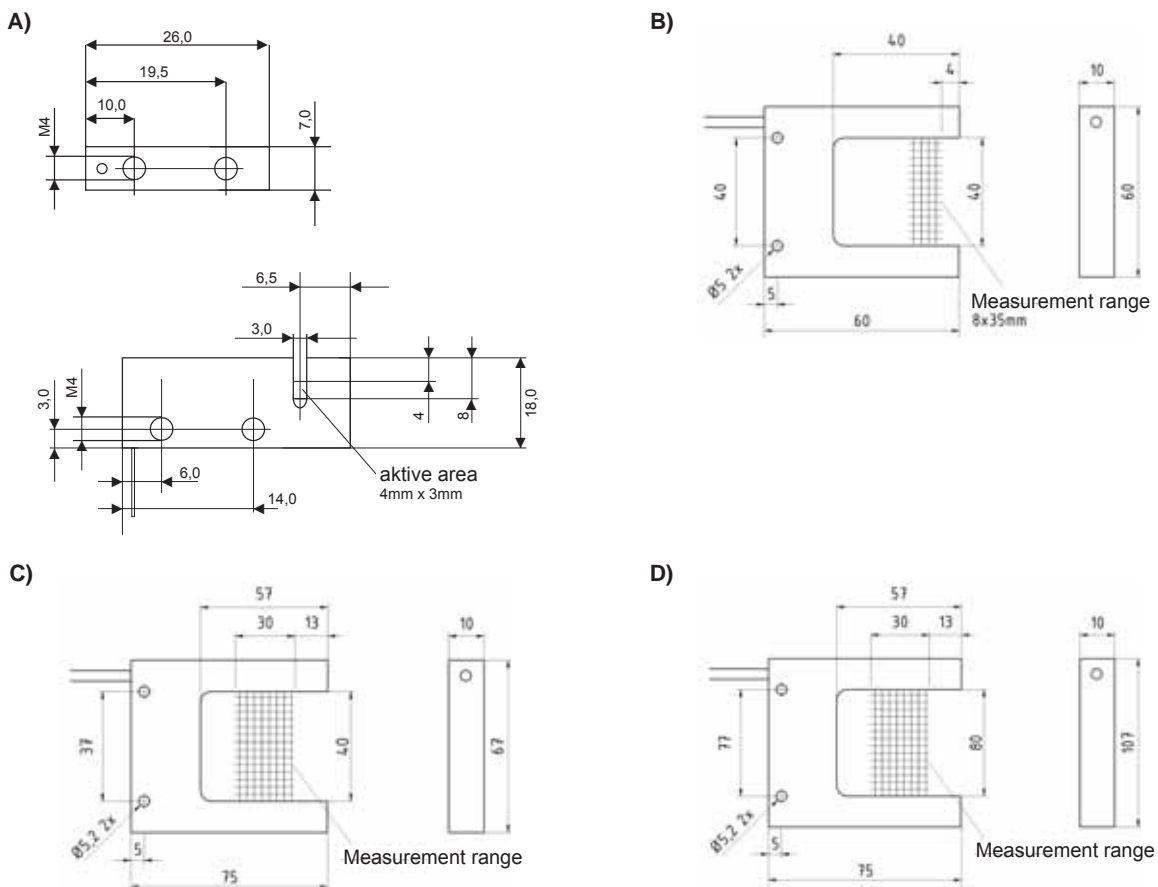



Amplifier V91

General data

Operating voltage	10 ... 30V DC
Output voltage	100mA
Output function	PNP and NPN, light/dark switchable
Sensor pulse extension	0/50ms (selected)
Display Operating/Signal strenght	LED green
Display Switching state/Signal strenght	LED yellow
Temperature range	-10°C ... +55°C
Protection class	IP65



Selection chart amplifier*

Article number	Designation	Functional principle	Limiting frequency	Response time	Max. sensor range	Connection
08369615000	V91-AP/N-00	unclocked	10kHz	70µs	50%	A
08369615050	V91-AP/N-01	unclocked	10kHz	70µs	50%	B
08369615100	V91-BP/N-00	clocked	500Hz	1,1ms	100%	A
08369615150	V91-BP/N-01	clocked	500Hz	1,1ms	100%	B
08369615200	V91-FP/N-00	clocked	3kHz	200µs	50%	A
08369615250	V91-FP/N-01	clocked	3kHz	200µs	50%	B

* suitable for all sensor heads in our catalogue

Dimension

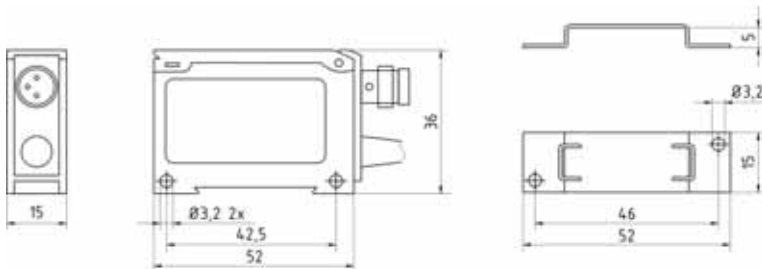

Circuit diagramm

A) PVC-Cable, 4-wire, 2m

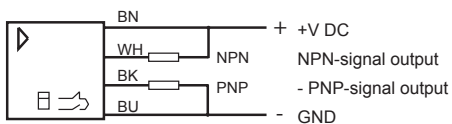

B) Connector, M8, 4-pole

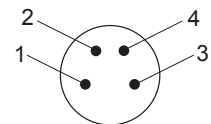
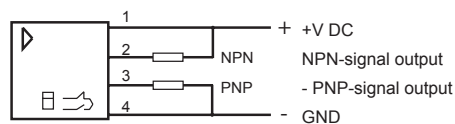



OPTICAL SENSORS MINI

Amplifier V10

General data

Operating voltage	10 ... 30V DC
Output current	200mA
Output function	PNP (NPN on request)
Sensor pulse extension (Switching output)	0 - 250ms (selectable)
Display operating/Switching state	LED green/yellow
Display signal strength	Display 3-digit
Temperature range	-10°C ... +55°C
Protection class	IP65



Selection chart amplifier switching*

Article number	Designation	Functional principles	Limit frequency	Response time	Max. sensor range	Dimension
08369617000	V10-AP-00	unlocked	10kHz	50µs	33%	A
08369617020	V10-AP-02	unlocked	10kHz	50µs	33%	B
08369617100	V10-BP-00	clocked	500Hz	1ms	100%	A
08369617120	V10-BP-02	clocked	500Hz	1ms	100%	B
08369617400	V10-FP-00	clocked	3kHz	167µs	33%	A
08369617420	V10-FP-02	clocked	3kHz	167µs	33%	B
08369617300	V10-GP-00	clocked, Auto-Sync	500Hz	1ms	100%	A
08369617320	V10-GP-02	clocked, Auto-Sync	500Hz	1ms	100%	B

Selection chart amplifier analogue*

Article number	Designation	Functional principles	Limit frequency	Response time	Max. sensor range	Dimension
08369617200	V10-C-00	clocked, Analogue 0-10V	1kHz	500µs	100%	C
08369617220	V10-C-02	clocked, Analogue 0-10V	1kHz	500µs	100%	D
08369617250	V10-D-00	clocked, Analogue 4-20mA	1kHz	500µs	100%	C
08369617270	V10-D-02	clocked, Analogue 4-20mA	1kHz	500µs	100%	D

* suitable for all sensor heads in our catalogue (excluded RLN)

Dimension

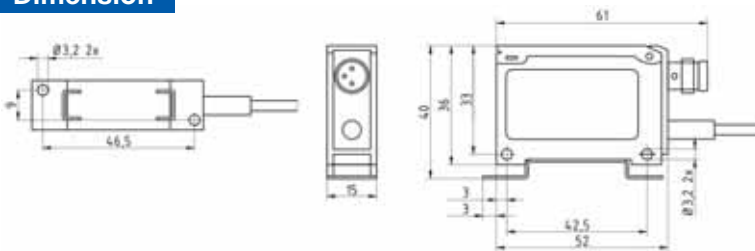

Circuit diagramm

A) PVC-cable, 5-wire, 2m

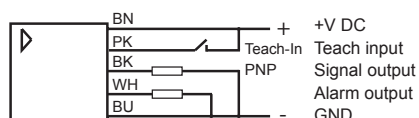

B) Connector M8, 4-pole

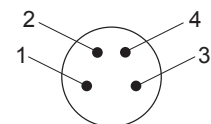
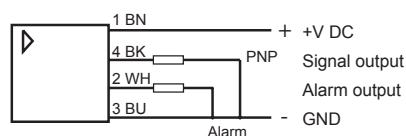

C) PVC-cable, 5-wire, 2m

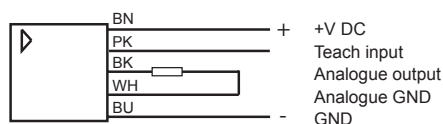

D) Connector M8, 4-pole

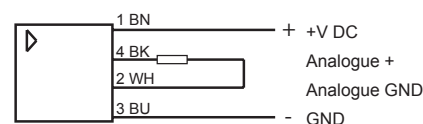



PRODUCT OVERVIEW

Reflective sensor

Designation	Article number	Matchcode	Page
KORT12-G2EB8-X0301 IR	08361601100	9960-1100	7
KORT12-G2EB8-X0301 RL	08361601150	9960-1150	7
KORT20-G2EB8-X0301 IR	08361601160		7
KORT12-M3MB8-X0301 IR	08361601200	9960-1200	7
KORT12-M3MB8-X0301 RL	08361601210		7
KORT20-M3MB8-X0301 IR	08361601220		7
KORT60-G5EB13-X0301 IR	08361601300	9960-1300	9
KORT60-G5EB13-X0301 RL	08361601400	9960-1400	9
KORT100-G5EB13-X0301 IR	08361601500	9960-1500	9
KORT60-G5EB13-X0301 RLM	08361601450		9
KORT60-M6MB13-X0301 IR	08361601600	9960-1600	9
KORT60-M6MB13-X0301 RL	08361601700	9960-1700	9
KORT100-M6MB13-X0301 IR	08361601800	9960-1800	9
KORT60-M6EB12-X0301 RLM	08361601750	9960-1750	9
KORT60-Q6MB12-X0301 IR	08361600000	9960-0000	10
KORT60-Q6MB12-X0301 RL	08361600100	9860-0100	10
KORT100-Q6MB12-X0301 IR	08361600200	9860-0200	10
KORT60-Q6MB12-X0301 RLM	08361600150		10
KORT200-Q6MB17-X0301 IR	08361600300	9860-0300	10
KORT60-Q3AB13-X0301 RLM	08361602300		10
KORT25-Q3AB13-X0301 RLN	08361602310		10
KORT60W-Q3AB13-X0301 RLM	08361602400		10
KORT25W-Q3AB13-X0301 RLN	08361602410		10
KORT70-Q3MB-X0301 RLM	08361602200		10
KORT20-Q3MB-X0301 RLN	08361602210		10

Fixed-focus reflective sensor

KORF7-Q4MB16-X0301 RLM	08361602100		10
------------------------	-------------	--	----

Retro-reflective light barrier clear class detection

KORS1500-Q6MB17-X0301 RL	08361600400	9860-0400	10
--------------------------	-------------	-----------	----

Through-beam light barrier

KOES100-G2EB8-X0301 RL	08363603200	9960-3200	7
KOES200-G2EB8-X0301 RL	08363603300	9960-3300	7
KOES300-G2EB8-X0301 IR	08363602000	9960-2000	7
KOES300-G2EB8-X0301 RL	08363602100	9960-2100	7
KOES800-G2EB8-X0301 IR	08363602200	9960-2200	7
KOES500-G2EB8-X0301 RLM	08363602150		7
KOES800-G2EB8-X0301 RLN	08363602160		7
KOES300-M3MB8-X0301 IR	08363602300	9960-2300	7
KOES300-M3MB8-X0301 RL	08363602400	9960-2400	7
KOES800-M3MB8-X0301 IR	08363602500	9960-2500	7
KOES500-M3MB8-X0301 RLM	08363602450		7
KOES800-M3MB8-X0301 RLN	08363602460		7
KOES1000-G4EB11-X0301 IR	08363602600	9960-2600	8
KOES1000-G4EB11-X0301 RL	08363602610		8
KOES2000-G4EB11-X0301 IR	08363602700	9960-2700	8
KOES2000-G4EB11-X0301 RLM	08363602650		8



PRODUCT OVERVIEW

Trough-beam light barrier

Designation	Article number	Matchcode	Page
KOES1500-G4EB11-X0301 RLN	08363602660		8
KOES1000-M5MB11-X0301 IR	08363602800	9960-2800	8
KOES1000-M5MB11-X0301 RL	08363602810		8
KOES2000-M5MB11-X0301 IR	08363602900	9960-2900	8
KOES2000-M5MB11-X0301 RLM	08363602850		8
KOES1500-M5EB11-X0301 RLN	08363602860		8
KOES4000-G5EB13-X0301 IR	08363603000	9960-3000	9
KOES4000-M6MB13-X0301 IR	08363603100	9960-3100	9
KOES4000-M6MB13-X0301 RL	08363603110		9
KOES1000-Q6MB12-X0301 IR	08363600500	9960-0500	10
KOES2000-Q6MB12-X0301 IR	08363600600	9960-0600	10
KOES1000-Q6MB12-X0301 RL	08363600620	9960-0620	10
KOES4000-Q6MB12-X0301 IR	08363600700	9960-0700	10
KOES4000-Q6MB12-X0301 RL	08363600720		10
KOES500-Q3AB13-X0301 RLM	08363603500		10
KOES800-Q3AB13-X0301 RLN	08363603510		10
KOES500W-Q3AB13-X0301 RLM	08363603600		10
KOES800W-Q3AB13-X0301 RLN	08363603610		10
KOES500-Q3MB5-X0301 RLM	08363102470	9960-2470	10
KOES800-Q3MB5-X0301 RLN	08363102480		10

Light-band-fork sensor

KOEG3-Q8AB4-X0301	08363605003	12
KOEG40-Q40AB8-X0301	08363605005	12
KOEG40-Q57AB30-X0301	08363605010	12
KOEG80-Q57AB30-X0301	08363605015	12

Amplifier

V91-AP/N-00	08369615000	8861-5000	13
V91-AP/N-01	08369615050	8861-5050	13
V91-BP/N-00	08369615100	8861-5100	13
V91-BP/N-01	08369615150	8861-5150	13
V91-FP/N-00	08369615200	8861-5200	13
V91-FP/N-01	08369615250	8861-5250	13
V10-AP-00	08369617000	8861-7000	13
V10-AP-02	08369617020	8861-7020	13
V10-BP-00	08369617100	8861-7100	13
V10-BP-02	08369617120	8861-7120	13
V10-FP-00	08369617400	8861-7400	13
V10-FP-02	08369617420	8861-7420	13
V10-GP-00	08369617300	8861-7300	13
V10-GP-02	08369617320	8861-7320	13
V10-C-00	08369617200	8861-7200	13
V10-C-02	08369617220	8861-7220	13
V10-D-00	08369617250	8861-7250	13
V10-D-02	08369617270	8861-7270	13